

UNIVERSITY OF CALIFORNIA

Los Angeles

Latent Transition Analysis:

Modeling Extensions and an Application to Peer Victimization

A dissertation submitted in partial satisfaction of the
requirements for the degree Doctor of Philosophy
in Education

by

Karen Lynn Nylund

2007

*To my Mom and Dad,
who taught me to dream big and never give up.
The best is yet to come.*

Table of Contents

Chapter 1: Introduction.....	1
Dissertation Goals and Contributions.....	1
The Study of Peer Victimization	5
Victim Groups Based on Severity	6
Victim Groups Based on Form of Victimization	7
Developmental Considerations in Determining Victim Groups.....	8
The Present Study of Peer Victimization.....	9
Data Description and Method.....	10
Participants.....	10
Procedure.....	11
Measure of Victimization	11
Covariates and Distal Outcomes.....	13
Demographic Characteristics.....	13
Issues of Attrition.....	15
Model Estimation	15
Chapter 2: The Latent Transition Analysis Model and Extensions.....	17
Longitudinal Models with Observed Outcomes.....	18
Continuous Observed Outcomes: The Growth Model	19
Continuous Observed Outcomes: Autoregressive Models.....	21
Categorical Observed Outcomes: Growth Modeling.....	23
Categorical Observed Outcomes: Autoregressive Models.....	24
Longitudinal Models with Latent Variable Outcomes	27

Defining the Latent Variable	27
Continuous Latent Outcomes	28
Categorical Latent Variable Outcomes	29
The Latent Transition Analysis Model.....	30
Latent Class Analysis (LCA)	31
LCA Model Parameters	32
The LTA Model.....	36
Measurement Model Specification	39
Deciding on the Number of Classes in LCA	39
Selection of the Measurement Model.....	42
Comparing the Fit of Measurement Models	43
Measurement Invariance	44
LTA Model Specification	47
Higher-Order Effects	47
Transition Probability Restrictions	48
Longitudinal Guttman Simplex.....	51
Covariates and Distal Outcomes.....	53
Assessing Model Fit	58
Analysis Steps	59
Step 0: Study Descriptive Statistics	60
Step 1: Study Measurement Model Alternatives for Each Time Point	60
Step 2: Explore Transitions Based on Cross-Sectional Results.....	61
Step 3: Explore Specification of the Latent Transition Model without Covariates	61
Step 4: Include Covariates in the LTA Model	62

Step 5: Include Distal Outcomes and Advanced Modeling Extensions	62
Summary	62
Chapter 3. Methods and Results	64
Step 0: Study Descriptive Statistics	66
Step 1: Study Measurement Model Alternatives for Each Time Point.....	68
Comparing Relative Fit of the Measurement Models	69
Deciding on the Measurement Model.....	71
Exploring the 3-class LCA Solution.....	78
Step 2: Explore Transitions Based on Cross-Sectional Results	95
Measurement Invariance	97
Step 3: Explore Specification of the Latent Transition Model without Covariates	101
Transition Probabilities: Stationary or Not?.....	101
Exploring First- and Second-Order Transitions.....	102
Step 4: Include Covariates in the LTA Model.....	108
LTA Model with Continuous Covariates	111
Higher-order Latent Class Variable: The Mover-Stayer Variable	115
Mover-stayer LTA Model with Covariates	118
Step 5: Include Distal Outcomes and Advanced Modeling Extensions	120
Second-Order Effect	126
Distal Outcomes.....	127
Conclusions	128
Chapter 4. Discussion and Conclusions	130
Peer Victimization Results	130
Victimization Based on Severity	130

Developmental Understanding of Peer Victimization.....	132
Strengths of LTA to the Study of Peer Victimization	133
Limitations to the Study of Peer Victimization.....	134
Modeling Ideas and Contributions	134
Modeling Limitations and Future Work.....	136
Generalizability	136
Measurement Models.....	138
Measurement Invariance	139
Modeling Heterogeneity in Development	140
LTA Models in a Larger Modeling Framework	140
Multiple Processes.....	141
LTA Modeling Ideas in a Cross-Sectional Setting.....	141
Applications Without an Exploratory Measurement Model.....	142
Multilevel LTA.....	143
Appendix A: Description of Variable Names Used in Analyses.....	145
Appendix B: Mplus Syntax for the Factor Analysis Model with 1-Factor.....	146
Appendix C: Mplus Syntax for the LCA Model with 3-Classes.....	147
Appendix D: Mplus Syntax for LCFA Model with 1-Factor, 2-Classes	148
Appendix E: Mplus Syntax for FMA Model 1-Factor, 2-Classes	150
Appendix F: Mplus Syntax for Invariant Transition Probabilities.....	152
Appendix G: Mplus Syntax for the Second-Order LTA Model	154
Appendix H: Mplus Syntax for First-Order LTA Model with Covariates, a Mover-Stayer Latent Variable, and a Distal Outcome (physical symptoms).....	156
Appendix I: Mplus Syntax for Second-Order LTA Model with Covariates and a Distal Outcome that Varies for Each Class of C3.....	160

References 162

List of Tables

Table 2.1. Transition matrix for two categorical variables, each with three categories.....26

Table 2.2. Example transition probabilities for an LTA model following a Longitudinal Guttman Simplex of using the math-skill acquisition example. Transition probabilities either are fixed at zero (0) or are freely estimated (*)52

Table 2.3. Transition probabilities for movers (left panel) and stayers (right panel)57

Table 3.1. Observed sample size and proportion endorsed for the six binary peer victimization survey items for grades 6, 7, and 866

Table 3.2. Covariates summary for grades 6, 7, and 8 and high school distal outcomes.....68

Table 3.3. Factor analysis, latent class analysis, latent class factor analysis, and factor mixture analysis measurement model results for grade 6 (N = 1,900).....72

Table 3.4. Factor analysis, latent class analysis, latent class factor analysis, and factor mixture analysis measurement model results for grade 7 (N = 1,714).....75

Table 3.5. Factor analysis, latent class analysis, latent class factor analysis, and factor mixture modeling measurement model results for grade 8 (N = 1,564).....76

Table 3.6. Conditional item probabilities for the 3-class LCA solution by grades 6, 7, and 8.....82

Table 3.7. Item response patterns for each victim class, presented by grade.....84

Table 3.8. Percent of students in each victimization class in grades 6 through 8 based on cross-sectional LCA without covariates87

Table 3.9. Logistic regression coefficients and odds ratio for 3-class model with school safety and gender (males = 0, females = 1) as a covariate using the nonvictimized class as the comparison group91

Table 3.10. Mean depressive feelings for the three victimization classes92

Table 3.11. Preliminary transition tables based on cross-sectional LCA results.....95

Table 3.12. Transitions probabilities for the stationary (left panel) and non-stationary (right panel) LTA models..... 102

Table 3.13. First-order transition probabilities for both the first-order LTA model (left panel) and the first- and second-order (right panel) LTA models where the transition probabilities are adjusted for the second-order effect.....	104
Table 3.14. Transition matrices for grade 7 to grade 8, presented by victimization class in grade 6 based on an LTA model with a second-order effect.....	105
Table 3.15. Transition probabilities for grade 6 to grade 8, collapsing over grade 7, using an LTA model with only a first-order effect (left panel) and using an LTA model with both a first- and second-order effects (right panel).....	106
Table 3.16. Logistic regression coefficients for LTA model with time-varying gender effect with non-stationary transitions and a first-order effect	109
Table 3.17. Estimated transition probabilities presented by gender (males on the left, females on the right) based on model with only gender as a covariate.....	110
Table 3.18. Logistic regression coefficients for 3-class model with anxiety, school safety, gender (boys = 0, girls = 1), and ethnicity covariates where the nonvictimized class is the comparison based on the second-order LTA model.....	113
Table 3.19. Percent of students in each class in grades 6 through 8 based on the mover/stayer LTA model without covariates	116
Table 3.20. Percent of students in each pattern of victimization of experiences, ordered by the largest to smallest pattern for movers and stayers	117
Table 3.21. Percent of students in one of the victimization classes in grades 6 through 8 based on final model	121
Table 3.22. Logistic regression coefficients for 3-class model with gender (boys = 0, girls = 1), school safety, depression, anxiety and ethnicity covariates, the nonvictimized class is the comparison based on the final LTA model.....	124
Table 3.23. Transition probabilities between grade 6 and grade 8, collapsing over grade 7 for the final LTA model with a second-order effect	127
Table 3.24. Mean (M) and standard deviation (SD) for grade 9 physical symptoms and social worries by grade 8 victimization class.....	127

List of Figures

Figure 2.1. Path diagram for a general growth model.....20

Figure 2.2. Path diagram for a generic first-order autoregressive model with continuous observed outcomes.....22

Figure 2.3. Model diagram for a multiple indicator growth model.....29

Figure 2.4. General latent class analysis diagram.34

Figure 2.5 Item probability plots for ordered (left) and unordered (right) LCA solution with binary outcomes.....34

Figure 2.6. A latent transition model diagram with three observed binary variables and three measurement points.37

Figure 2.7. A latent transition model diagram with three observed binary variables and three measurement points, including a first- and second-order effect.48

Figure 2.8. Model diagram of an LTA model with a time-invariant covariate (gender) and a time-varying covariate (depression).55

Figure 2.9. Model diagram of the LTA model with a higher-order latent class variable, C ...56

Figure 2.10. Model diagram of the LTA model with a higher-order latent class variable and a distal outcome.58

Figure 3.1. Conditional item probability plots for the 3-class LCA by grades 6, 7, and 8. Class size information is in the legend. *Note:* VI class = victimized class, SV class = sometimes-victimized class, NV class = nonvictimized class.80

Figure 3.2. Latent class regression model diagram with covariates (female and school safety) and distal outcome (depressive feeling for the fall of the following school year).....89

Figure 3.3. LCA model with gender as a covariate that has a direct effect on item (u_2) and on the latent class variable used to explore differential item functioning.....93

Figure 3.4. LTA model with first-order effect (arrow with straight connector lines) and a second-order effect (arrow with dashed connector line)..... 103

Figure 3.5. Model diagram of the LTA with first- and second-order effect, non-stationary transition probabilities, and time-varying effects of covariates..... 112

Figure 3.6. Mover-Stayer LTA model with gender and ethnicity, and time-varying covariates depression and anxiety and two distal outcomes.	119
Figure 3.7. Second-order LTA model with gender and ethnicity, and time-varying covariates of depression and anxiety and a distal outcome.....	121

ACKNOWLEDGEMENTS

VITA

November, 1977	Born, Los Angeles, California
1999	Woman Student Leader of the Year Award
2000	B.S., Mathematics, Minor in Statistics Sonoma State University Rohnert Park, California
2001	Survey Sampling Intern Westat, Inc. Washington, D.C.
2002	M.S., Survey Research and Methodology University of Nebraska, Lincoln Lincoln, Nebraska
2002-2007	Graduate Student Researcher Graduate School of Education & Information Studies University of California, Los Angeles

PUBLICATIONS AND PRESENTATIONS

- Buskirk, T., Joseph, J., & Nylund, K. (May 2002). *Surveying teens: Investigating non-response methodology in substance abuse surveys*. Poster presented at the annual meeting of the American Association of Public Opinion Research. St. Petersburg, FL.
- Lambert, S., Nylund, K. L., Copeland-Linder, N., Ialongo, N. S. (March 2007). *Patterns of community violence exposure among urban adolescents: Predicting level of exposure*. Paper presented at the biannual meeting of the Society for Research on Adolescence, Boston, MA.
- Nishina, A., Bellmore, M., Witkow, M. R., & Nylund, K. (March 2006). *Who am I? The development of ethnic identification in a multi-ethnic society*. Poster presented at the biannual meeting of the Society for Research on Adolescents, San Francisco, CA.
- Nylund, K. L., Asparouhov, T. & Muthén, B. (in press). Deciding on the number of classes in mixture analysis: A Monte Carlo simulation study. *Structural Equation Modeling: An Interdisciplinary Journal*.

- Nylund, K. L., Bellmore, A., Nishina, A., & Graham, S. (in press). Subtype, severity, and structural stability of peer victimization: What does latent class analysis say? *Child Development*.
- Nylund, K. L. (May 2006). *An alternative discrete growth modeling: Extensions of the latent mixed Markov chain model*. Paper presented at the annual meeting of the Society for Prevention Research, San Antonio, TX.
- Nylund, K. L. (May 2006). *The bootstrap likelihood ratio test: A promising tool for class enumeration in mixture models*. Paper presented at the annual meeting of the Society for Prevention Research, San Antonio, TX.
- Nylund, K. L., Muthén, B. & Asparouhov, T. (May 2005). *Class enumeration for latent class models: Results of a simulation study considering the Lo-Mendell-Rubin test*. Poster presented at the annual meeting of the Society of Prevention Research, Washington, D.C.
- Nylund, K. L., Muthén, B. (May, 2005). *Longitudinal mixture modeling: Latent mixed Markov chain modeling change in self-reported victimization in middle school students*. Paper presented at the annual meeting of the Society of Prevention Research, Washington, D.C.
- Nylund, K., Bellmore, A., Nishina, A., Graham, S., & Juvonen, J. (April, 2005). The state of victimization during middle school: A latent transition mixture model approach. Paper presented at the biannual meeting of the Society for Research in Child Development, Atlanta, GA.
- Nylund, K., Bellmore, A., Nishina, A., Graham, S., Juvonen, J., & Muthén, B. (April 2005). A new application in longitudinal mixture modeling: Latent transition mixture modeling. Paper presented at the annual meeting of the American Educational Research Association, Montreal, Canada.
- Nylund, K., Muthén, B. & Asparouhov, T. (April 2005). Class enumeration for latent class models: Results of a simulation study considering the Lo-Mendell-Rubin test. Paper presented at the annual meeting of the American Educational Research Association, Montreal, Canada.
- Nylund, K. (May 2004). Approaches for modeling change in nonnormal continuous latent factors with ordered polytomous indicators. Paper Presented at the annual meeting of the Society for Prevention Research, Quebec, Canada.
- Yamashiro, K., & Nylund, K. (April 2006). *Examining the indicators and the Classifications behind AYP: Using LCA to explore school performance*. Paper presented at the annual meeting of the American Educational Research Association, San Francisco, CA.

ABSTRACT OF THE DISSERTATION

Latent Transition Analysis:
Modeling Extensions and an Application to Peer Victimization

by

Karen Lynn Nylund

Doctor of Philosophy in Education

University of California, Los Angeles, 2007

Professor Bengt Muthén, Chair

Latent transition analysis (LTA) is a type of longitudinal analysis that explores change in latent classes of individuals over time. Applications of LTA can be found in a range of social science disciplines that address a variety of topics such as modeling progression through drug use and abuse stages, studying children's drawing development, and exploring patterns of criminal behavior. LTA builds on two modeling traditions: latent class analysis (LCA) and autoregressive modeling, specifically Markov models. Latent class analysis, a latent variable mixture model, is used as a measurement model in LTA to identify unique classes (i.e., groups or statuses) at each point in the analysis. The autoregressive component describes transitions among the classes that occur over time. LTA simultaneously defines the classes and models individual-level change among them that occur over time.

This dissertation describes an advanced application of LTA that highlights several modeling extensions not common in other applications. These extensions include the use of

covariates that allow for time-specific relationships with outcomes, a higher-order effect that tests if there is a lasting impact of early classification, a latent covariate in the form of a mover-stayer variable as a way to describe heterogeneity in development, and distal outcomes predicted by developmental patterns.

One of the aims of this dissertation is to present the LTA model and its extensions in a pedagogical way, illustrating how one can specify the model, which research questions the model can address, and how researchers can interpret the model's results. LTA is a type of structural equation model (SEM) comprised of both a measurement and structural model. This dissertation introduces five model-building steps, providing practical guidelines for how to specify the model. The steps begin with descriptive cross-sectional explorations of the data, then selecting a measurement model for each time point, eventually building up to a final LTA model that integrates results and insights gained from the careful application of the steps.

This dissertation applies the analysis steps to a dataset aimed at studying change in the peer victimization experiences of approximately 1,300 urban, public-school students across the three middle school years (grades 6, 7, and 8). The systematic application of the steps involves a discussion of modeling results that highlights ways in which each step's results contribute to the understanding of students' peer victimization experiences in middle school. The analyses yielded three victimization classes based on degree: victimized, sometimes-victimized, or nonvictimized. Results indicated that when students transitioned between victimization classes, they most likely moved from a more victimized class to a less victimized one. Further, results indicated that compared to students who do not experience any sort of victimization, victimized students feel less safe at school, more socially anxious,

and more depressed during certain middle school years. Students who were in the victimized class in grade 8 reported more physical health problems and more social worries once in high school than students who were in the other victimization groups. Together these findings can help teachers and researchers understand the peer victimization experiences of middle school students and may help in developing programs aimed at reducing the effects for students who are victimized.

Chapter 1: Introduction

In the past few decades, longitudinal methodology has become a more commonly used tool for researchers focused on understanding and describing change. This increase in use is likely the result of more longitudinal data being collected as well as the development of more methodologies that can be used to analyze such data. Publications that demonstrate novel applications of longitudinal methods have helped to make these methods more familiar and accessible to researchers doing applied work. In addition, statistical software packages for estimating longitudinal models have become more flexible and user-friendly, enabling applied researchers to more easily apply these methods to their data.

There is a variety of models that are available for analyzing longitudinal data and the choice of which model to use may be far from straightforward. Many of the longitudinal methods model change in slightly different, but not opposing, ways. Rather, there are different approaches that address different sets of research questions, and these approaches can be modified or customized to suit particular applications. Thus, it is often up to the researcher to decide which of the available longitudinal methods is most appropriate for a given set of research questions and datasets. One of the goals of this dissertation is to describe and illustrate one type of longitudinal method, latent transition analysis (LTA), in a way that both demonstrates which research questions the model can address and provides practical tools researchers can use in applying the model.

Dissertation Goals and Contributions

This dissertation has three primary, complementary goals. The first is to introduce LTA and illustrate novel modeling extensions. By exploring time-to-time transitions in

discrete latent outcomes, the LTA model takes a different approach to describing change than the more commonly applied growth models. The introduction begins by placing LTA in a broader modeling context, which includes a comparison to other longitudinal methods. Modeling extensions include the use of covariates that allow for time-specific relationships, higher-order effects, a latent covariate in the form of a mover-stayer variable, and distal outcomes predicted by developmental patterns.

The second goal of this dissertation is to use the LTA model to explore unanswered research questions about the development of self-reported peer victimization using a longitudinal sample of middle school students. This application of LTA includes a way to empirically derive groups of students based on their victimization experiences and then models the development of these experiences throughout middle school. Important covariates of victimization are included in the model and are used to study how the relationships of these variables with victimization change over time. The lasting impacts of early victimization experiences are investigated using a higher-order effect, and middle school victimization experiences are related to high school outcomes (i.e., distal outcomes).

The third goal of this dissertation is to develop a pedagogical presentation of LTA models and their applications in a real data setting. The use of the analysis steps and their careful application to the peer victimization data provide a more in-depth look at the modeling process than is common in other LTA applications. Practical considerations involved in specifying an LTA model are discussed, including how to decide on an appropriate measurement model and how to interpret results. Further, the syntax for all models considered in this dissertation as implemented in the Mplus software (Muthén & Muthén, 1998-2007) is included in the appendices. The proposed analysis steps and their

discussions highlight the ways in which the method informs both our understanding of peer victimization as well as how our understanding of peer victimization informs the application of the method.

The goals of this dissertation map onto three unique contributions:

- Contribution 1: To provide a pedagogical introduction of the LTA models and modeling extensions. These extensions include exploring an extensive set of measurement models, the inclusion of continuous and discrete covariates and predictors including time-varying covariates with time-varying effects, a higher-order transition effect, a second-order mover-stayer variable, and differences in distal outcomes that vary by developmental trajectories.
- Contribution 2: To provide substantive contributions to the understanding of self-reported victimization, including (a) an empirically-based method of classifying victimization experiences and (b) longitudinal data analysis results that describe individual change in victimization classification throughout middle school.
- Contribution 3: To provide insight into the application of LTA to data using analysis steps that highlight the ways the model is specified and interpreted, decisions made in the application, and discussions of the intermediate and final modeling results. Concrete examples of how to specify the models are provided, including the syntax for Mplus, the statistical software used in this application.

The contributions of this dissertation are separated into three chapters. Chapter 2 introduces LTA and places the model in the broader context of other longitudinal models.

This includes describing how the choice of method is based in part on the nature of their outcomes. Chapter 2 compares models appropriate for use with continuous versus categorical variable outcomes, as well as models for observed versus latent outcomes, and the intersection of the two (e.g., modeling change in continuous observed outcomes or latent categorical outcomes). A general modeling description presented in Chapter 2 helps to position the LTA among other longitudinal models. The second chapter ends with the list of model building steps that can be used to guide the specification of a series of LTA models.

Chapter 3 applies the analysis steps presented in Chapter 2 to the peer victimization dataset. Beginning with descriptive statistics, the analysis steps are used to build a longitudinal model that includes many modeling extensions. For each of the steps, a discussion of the results is included that highlights the ways in which information gained at each step can be used in subsequent steps. As a result of the model building process, some intermediate modeling results that are discussed in this chapter may not be directly integrated into the final model. The presentation of results using this orientation provides insight into the decisions involved in the process that one may go through when conducting longitudinal research. Consequently, the third chapter, entitled “Methods and Results,” is non-traditional in the sense that it systematically guides the reader through the analysis steps while simultaneously discussing results.

As the goals of this dissertation are overlapping, Chapter 4 includes the discussion of several sets of results. The concluding chapter begins with a discussion of the modeling results and the how they contribute to our understanding of peer victimization. The chapter also includes discussions about the modeling process employed and the ways it facilitated a careful application of the method to study peer victimization. Also included is a discussion

of the implications and limitations of the study. Chapter 4 closes with a discussion of modeling extensions and ideas for future research.

The remainder of Chapter 1 focuses on the study of peer victimization, the data used in this study, and the model estimation details. First is an introduction to the study of peer victimization in middle school and why it is an important construct to study. The next section highlights the ways in which the LTA model directly addresses unanswered research questions about the way victimization is measured and about students' development through middle school. This is followed by a section that describes the specific dataset, procedures, and measures used in this dissertation. The chapter ends with a summary of modeling and estimation details.

The Study of Peer Victimization

It is well established in the literature that peer victimization is associated with a host of adjustment difficulties during childhood and adolescence. The difficulties range from psychological maladjustment and peer rejection to physical health problems (e.g., physical complaints, frequent nurse visits, school absences) and academic problems such as poor school performance (Juvonen & Graham, 2001). Nevertheless, important gaps remain in our understanding of students' peer victimization experiences. For example, there are inconsistencies in the criteria researchers use to identify victims and nonvictims (Ladd & Kochenderfer-Ladd, 2002).

Classifying students into groups is a useful technique for understanding individual differences in development (Magnusson & Cairns, 1996) and is employed by peer-relations researchers interested in subgroups of aggressors and victims (Schwartz, 2000). When

classifying students into different victimization risk groups—for example, to predict maladjustment—it is important that the groups accurately reflect the key differences among students. However, some studies classify students into groups based on victimization severity or frequency, while others seek to understand differences in risk based on experiencing different forms of peer victimization. Without use of the same criteria, it is difficult to establish consistent subgroup differences.

Victim Groups Based on Severity

Studies that specify victimization groups based on severity typically rely on standard deviations from the sample mean to classify students into groups, such as victims and nonvictims (e.g., Graham, Bellmore, & Mize, 2006; Graham & Juvonen, 1998; Juvonen, Graham, & Schuster, 2003; Olweus, 1993; Perry, Kusel, & Perry, 1988; Schwartz, 2000). This method often utilizes self-ratings (e.g., frequency of victimization experiences) and peer nominations (e.g., strength of victim reputation among classmates). While this classification approach yields valid associations between extreme-group membership and social-psychological functioning, it has several potential problems. First, there are no clear guidelines regarding where to place cut-off scores or how many groups to create, regardless of whether raw- or z -scores are used. Second, when standardized cut-offs are used (i.e., z -scores), a student's classification becomes dependent on both the student's own victimization score as well as variations in victimization among peers. This problem is magnified when comparing victimization groups across time.

Victim Groups Based on Form of Victimization

Another hotly contested and yet-to-be-resolved issue in the study of peer-directed aggression is that of the form(s) that it takes (see, Archer & Coyne, 2005; Little, Jones, Henrich, & Hawley, 2003). There appear to be different forms of peer victimization (cf. physical, verbal, relational), and some researchers believe it is important to distinguish between victims who experience physical harassment and those who are targets of more covert intimidation tactics, such as social exclusion (see Smith, Cowie, Olafsson, & Liefoghe, 2002).

Classification of victims by types of experience is questionable in light of empirical evidence showing that different forms of victimization are highly correlated and that many targets are victimized in multiple ways. For example, Bellmore and Cillessen (2006) reported alphas above .90 of middle school students' composite peer-reported victimization scores based on general (e.g., "picked on"), physical, and relational victimization nomination items. High levels of intercorrelation suggest that children who experience one type of victimization also experience the other types of victimization measured in these studies.

The present study used a person-centered latent variable approach to address the debate concerning victimization type and to explore the developmental course of peer victimization during adolescence. As noted above, researchers interested in examining differences between victim types have commonly classified children into groups based on cut-off scores. Despite its utility, this method imposes differences between children that may not be meaningful or may result in classification errors including false positives and false negatives. Further, these differences may dampen the ability to predict differences in psychosocial adjustment. In addition to these measurement problems, inaccurate cut points

also have important practical implications for estimating the prevalence of victimization and for successfully designing and implementing interventions (Solberg & Olweus, 2003).

Developmental Considerations in Determining Victim Groups

Correctly classifying students into victimization groups requires knowledge about the developmental course of peer victimization across childhood and adolescence. Variations in the prevalence and/or forms of victimization experienced at different ages or grades may exist as a function of the individual or contextual characteristics that are present at different points in development (Smith, Madsen, & Moody, 1999). For several reasons, the middle school years promise to be an important period during which to study the developmental course of peer victimization. First, research suggests that during adolescence victims of peer harassment are among the most rejected students in their peer group (Boivin, Hymel, & Hodges, 2001). Second, several recent, large, nationally-representative studies have found that, at least from a cross-sectional perspective, the frequency and prevalence of peer victimization peaks during the early middle school years (Kaufman et al., 1999; Nansel et al., 2001). That is, the percentage of students who report being victimized at least occasionally by their peers is highest during sixth grade, when students are typically in their first year of middle school, and decreases somewhat steadily during the later middle school years.

These cross-sectional data suggest that for some students, peer victimization experiences may be largely confined to the early middle school years (Nansel et al., 2001), though this remains an empirical question to be answered with longitudinal data. Research pointing to this peak has been mainly cross-sectional (Salmivalli, 2002). Less is known about what happens longitudinally, and it is likely that peer victimization does not decrease for all

youth. At the same time, while a host of research studies have identified antecedents, covariates, and consequences of peer victimization (Hawker & Boulton, 2000; Juvonen & Graham, 2001), less is known about the covariates (especially time-varying covariates) that might predict victimization over time. There is also limited research about the extended consequences associated with different patterns of peer victimization (cf., chronically victimized, consistently nonvictimized) (Juvonen, Nishina, & Graham, 2000).

The Present Study of Peer Victimization

This dissertation used LTA to model change in student's self-reported peer victimization in a large sample of middle school students across the spring of sixth, seventh, and eighth grades. The first task was to use a person-centered latent variable approach to address the debate concerning victimization type. Once the classification of students into victimization classes (i.e., groups) was settled, the next task was to explore the developmental course of peer victimization during adolescence

The latent class analysis (LCA) empirically identified groups of students based on their victimization experiences. In the context of LCA, these groups are referred to as classes. Once the classes of students were identified and validated, LTA was used to study transitions and transition patterns across victimization classes throughout the middle school years. This approach enables the exploration of several important questions about the development of victimization and how victimization relates to key psychosocial variables such as depressive symptoms, social anxiety, perceived school safety, physical symptoms, and social worries. While several cross-sectional studies suggest that students experience the most victimization early in middle school (Nansel et al., 2001), this research assessed this

claim longitudinally. Further, this application examines the question of whether students' earlier victimization classification predicted later victimization (e.g., are there lasting effects of sixth grade victimization status on eighth grade status?). Lastly, to explore whether the timing of one's victim classification is important, the current study examined whether psychological maladjustment was differentially associated with victim class membership in grades six, seven, and eight.

In sum, LTA is particularly relevant to study the development of peer victimization through middle school for two reasons. First, it uses a person-centered model-based approach to identify classes of students based on their victimization experiences. Thus, LTA does not rely on external criterion or cut points to derive the victim classes. Second, LTA models the developmental patterns of students' peer victimization classifications over time, addressing research questions about change and the extent to which external variables are related to change.

Data Description and Method

Participants

The participants in this study come from a larger longitudinal study currently taking place at the University of California, Los Angeles (UCLA). Participating students attended one of 11 public middle schools located in predominantly low socioeconomic status (SES) neighborhoods in the greater Los Angeles, California area. The overall sample was ethnically diverse (44% Latino, 26% African American, 10% Asian, 9% Caucasian, and 11% multiethnic). The exact sample size for the analyses varied across each wave of data collection (due to attendance, attrition, response bias, etc.) from sixth to eighth grade.

Specifically, there were 1,900 (54% girls), 1,714 (55% girls), and 1,564 (56% girls) participants in the spring of sixth, seventh, and eighth grades, respectively. These sample sizes reflect participation rates that ranged between 99% and 75% for Waves 1 and 6, respectively. Students belonged to one of two cohorts: Cohort 1 was recruited in sixth grade in 2000 and Cohort 2 was recruited in sixth grade in 2001.

Procedure

Students were initially recruited from their homeroom during the fall of sixth grade, and both written parental consent and student assent were obtained. Seventy-five percent of parents who were initially contacted returned completed consent forms. Of these parents, 89% provided written consent for their child to participate. At each wave, as part of a larger survey protocol conducted within a single classroom period, students completed self-report measures that included the peer victimization measure among other measures of social, psychological, and academic functioning. The survey was administered to students once each semester (i.e., every fall and spring) throughout their entire three-year tenure in middle school. During sixth grade, the school received \$5 for every completed survey, to benefit the classroom (for the purchase of supplies, for example). In subsequent years, individual students received \$5 each time they completed a survey.

Measure of Victimization

At each time point, students completed a six-item modified version of Neary and Joseph's (1994) Peer Victimization Scale. This measure was designed to be embedded in Harter's (1987) Self-Perception Profile for Children to reduce social desirability biases. Each item in the scale describes two types of individuals: "[s]ome kids are not called bad names by other kids, BUT, other kids are often called bad names by other kids." For each item,

students were asked to circle which type of individual was most like them and indicate whether it was “sort of true for me” or “really true for me.” Doing this created a 4-point scale for each item, with higher scores indicating higher levels of peer victimization. The original scale had two items that reflect general victimization (“picked on” and “laughed at”), one item that assesses verbal victimization (“called bad names”), and another that assesses physical victimization (“hit and pushed around”). Additional items reflected relational victimization (“gossiped about”) and property damage/theft (“gets their things taken or messed up”), another form of victimization relevant to large urban schools.

Because the interest is in whether students experience victimization, these items were dichotomized such that 0 reflects any not-endorsed item (i.e., a rating of 1 or 2; reflecting a child who does not report getting picked on), and 1 reflects an endorsed item (i.e., a rating of 3 or 4; where the child does report such a problem). The dichotomized responses made sense conceptually because the scale required each student to first decide which hypothetical individual he or she felt most similar to. Thus, these items measured whether the student endorsed each of the six items rather than the degree of endorsement for each one. Also, the dichotomous items made practical sense, keeping in mind the extensive longitudinal analysis for which they will be utilized.

In preliminary cross-sectional analyses, a unique response pattern emerged as a separate class in LCA analyses. Upon further investigation, this very small class appeared to represent a response bias class of students who responded on the same serial position on the page, regardless of whether the item was worded in a negative or positive direction (i.e., reverse-coded). Students who showed evidence of such bias were removed from the analyses

for that wave. Across the waves of data collection, this resulted in removing 1.3% (n = 31) to 2.9% (n = 68) of the sample from a given wave.

Covariates and Distal Outcomes

Demographic Characteristics

Students self-reported gender on the questionnaire. They also self-reported race/ethnicity, choosing from 1 of 10 ethnic categories or providing an open-ended description of their race/ethnicity. Responses were aggregated into five primary racial/ethnic categories: Latina/o, African American, Asian, Caucasian, and biracial/multiethnic. Preliminary analyses revealed that 40% of students changed their race/ethnicity identification at least once in their self-reported middle school surveys (Nishina, Bellmore, Witkow, & Nylund, 2006). For students whose self-reported ethnicity changed across time points, categorization into one of the five aggregate racial/ethnic groups was determined by identifying which racial/ethnic group the student identified in the majority of the available survey waves (sixth through tenth grades). The five ethnic group variables were included in the model using dummy coding, where the reference group was the Caucasian group.

Perceived school safety. Students' perceptions of school safety were measured using a 10-item subscale of the Effective School Battery (Gottfredson, 1984). Items tapped general perceptions of safety at school and on the way to school (e.g., "How often do you feel safe while in your school building?") and were rated from (*never*), to 5 (*always*). A mean of the items was calculated, such that higher scores reflect stronger perceptions of school safety. Alpha coefficients for this sample ranged from .73 to .83 across waves.

Depressive symptoms were measured using the 10-item short form of the Children's Depression Inventory (Kovacs, 1992). Using this scale, students were presented with three sentences that described, "how kids might feel" and asked to indicate which sentence best described how they have been feeling in the past two weeks. For each item, the student could mark 0, 1, or 2. The ratings represented self-evaluations, as follows: 0 (*I do most things okay*), 1 (*I do many things wrong*), and 2 (*I do everything wrong*). The mean of the 10 items was used in the analysis, with higher scores indicating a greater prevalence of depressive symptoms. Alpha coefficients ranged from .79 to .85 across waves.

Social anxiety was measured using 9 of 12 items from the Fear of Negative Evaluation and Social Avoidance and Distress scales—general subscales of the Social Anxiety Scale for Adolescents (La Greca & Lopez, 1998). Three items from the Fear of Engagement Evaluation subscale that could be construed as peer harassment were removed to avoid construct overlap. Items were measured on a 5-point scale ranging from 1 (*never true*) to 5 (*always true*). Examples include: "I worry about what others think of me," and "I'm quiet when I'm with a group of people," for fear of negative evaluation and social avoidance and distress-general, respectively. A mean of the nine items was used in the analysis, where higher mean scores indicated higher levels of self-reported social anxiety. Alpha coefficients ranged from .80 to .82 across waves

High school physical symptoms were assessed in the fall of grade 9 with a list of 12 symptoms (modified from Resnick et al., 1997; Udry & Bearman, 1998), for example "headaches," and "sore throat/coughs." Students indicated how often they had experienced each symptom in the previous two weeks (1 = *not at all*; 4 = *almost every day*), with higher means reflecting more physical symptoms ($\alpha = .81$ for this sample).

High school social worries were measured using a modified four-item version of the High School Performance Scale (Nukulkij, Whitcomb, Bellmore, & Cillessen, 1999). Rated on a 5-point scale (1 = *never*; 5 = *all the time*), items tapped students' worries about their high school social experiences (for example, "Now that I am in high school, I worry that I won't have any friends"). Higher mean scores reflect more worries about social problems in school ($\alpha = .85$ for this sample).

Issues of Attrition

The larger longitudinal study from which these data are drawn initially recruited approximately 2,300 sixth-grade students. In the spring of eighth grade, 75% of the initial sample ($n = 1,704$) remained in the study. Since the average student mobility rate for the 11 participating schools was quite high (41%), this 75% retention rate is satisfactory. The retention rate is also comparable to other longitudinal studies with similar urban youth samples (Roeser & Eccles, 1998; Seidman et al., 1994). In addition, t-tests comparing retained students versus students lost through attrition on sixth grade variables included in the current study revealed that retained students had higher initial grade point averages but otherwise did not differ in other academic, behavioral, or school climate variables from attrited students. The larger longitudinal study continued to follow students as they transitioned from the 11 middle schools to over 100 high schools in the greater Los Angeles area. The retention rate from eighth to ninth grade was greater than 80%.

Model Estimation

All of the models presented in this dissertation were analyzed using the statistical software Mplus 4.2 (Muthén & Muthén, 1998-2007). Estimating LTA models in Mplus

allows for missing data on the measured outcomes using Full Information Maximum Likelihood (FIML) estimation (for more on FIML see, for example, Enders & Bandalos, 2001). Maximum likelihood estimates were obtained via the Expectation Maximization (EM) algorithm (Dempster, Laird, & Rubin, 1977), an iterative estimation scheme that can obtain maximum likelihood estimates for incomplete data, where latent variables are incomplete for all individuals in the sample. As a result, in both the preliminary cross-sectional and longitudinal models used in this dissertation, students were only eliminated from the analysis if they were missing on all observed outcomes used in the analysis (e.g., if in the longitudinal analysis a student was absent for each Spring semester) or if they were missing on the covariates. Multiple imputation techniques, which replace missing outcome and covariate information to preserve sample size, are available but not necessary for this study because there was not an excessive amount of missing data.

The modeling results account for the non-independence of students nested within schools by adjusting to the standard errors using a sandwich estimator.¹ Students came from 11 different schools, which are too few to explicitly model the nested nature of the data (e.g., using multilevel modeling). They were further nested within classrooms, but the longitudinal nature of the study meant that students moved among classrooms throughout middle school. As a result, there is not a single classroom variable that can be used to cluster at that level.

¹ In Mplus, this adjustment is specified using “type = complex,” where the user must name the clustering variable. In this application the clustering variable was a student’s middle school.

Chapter 2: The Latent Transition Analysis Model and Extensions

This chapter introduces the latent transition analysis (LTA) model, the longitudinal model that is the focus of this dissertation. LTA is a type of autoregressive model that can describe change in latent categorical variables. This chapter presents the LTA model in a broader longitudinal modeling context to facilitate comparisons with other common models. Further, this chapter includes details related to the specification of the LTA model. The chapter concludes by presenting a series of model-building steps that researchers can use when applying LTA to a dataset.

Many applications of longitudinal models can describe changes in directly observable outcomes. That is, the outcome of interest is directly measured over time, and the model summarizes and describes changes that occur. The LTA model describes change in outcomes where the outcomes are *not* directly observed. That is, the outcomes in LTA models are latent and are indicated by a set of observed variables. Further, the outcome for LTA is a categorical variable. Modeling change in latent variable outcomes may not be familiar to some researchers. Even further, modeling change in a categorical outcome, latent or observed, may also be unfamiliar to researchers.

This chapter introduces the modeling ideas and begins by describing models that explore change in observed outcomes, eventually showing how the same modeling ideas can be used to study change in latent variables. Two types of models serve as examples: a growth curve model and an autoregressive model. A brief description of each model type is included that highlights the ways in which the models can be used to describe change, considering both continuous and categorical outcomes. This section then shows how both growth and

autoregressive models can be used to describe change using both observed outcomes and latent variables.

The descriptions of the models in this chapter are not representative of all longitudinal models, but highlight important features of each model for the sake of comparison. Many technical details are omitted because the focus of this chapter is on general descriptions. For more information on growth curve modeling see, for example, Raudenbush and Bryk (2002), Duncan, Duncan, Strycker, Li, and Albert (1999), and Singer and Willet (2004). Descriptions and applications of longitudinal models with categorical outcomes can be found in Fitzmaurice, Laird, and Ware (2004), Molenberghs and Verbeke (2005), and Hedeker and Gibbons (1994), among others. For more on applied autoregressive or Markov models see Böckenholt (2005), Collins and Sayer (2001), Mooijaart (1998), and Van de Pol and Langeheine (1990).

Longitudinal Models with Observed Outcomes

Describing change in continuous observed outcomes is common in applications of longitudinal models. A continuous outcome, sometimes called a quantitative variable (versus qualitative), is one that can assume a large number of values, in theory, any value between the lowest and highest points on the measurement scale (e.g., achievement scores, weight, or depression). Observed continuous outcome variables are often assumed to be normally distributed. This chapter considers two models for describing change: (a) a growth curve model and (b) an autoregressive model. The choice of which type of model to use depends on the research questions asked because the models provide different, but not necessarily opposing, perspectives on the description of change.

Growth curve models describe change using continuous growth factors. These growth factors are specified in a way that describes the starting point and average rate of change for a continuous change process, along with individual variability around the growth factors. Autoregressive models describe time-to-time change, where the underlying change process is discontinuous; that is, not a smooth or constant change process. The following section provides a brief introduction of the growth curve model and autoregressive model, beginning with the most straightforward setting of observed continuous outcomes. The next section then includes a brief description of each of these models, where the outcomes are categorical.

Continuous Observed Outcomes: The Growth Model

The growth curve model, in a simple form with observed continuous outcomes, describes individual differences in repeatedly measured outcomes using growth factors and their associated means and variances. The intercept growth factor mean describes the average initial status value when centering at the first time point², and the intercept growth factor variance describes the amount of individual variation in the growth process at this time point. The slope growth factor mean describes the average rate of change between time points, and the slope factor variance describes the variation in the individual growth rates. Using a math achievement example, the interpretation of growth factors means could be as follows: “In grade six, the average math score was 80, and, on average, students’ scores improved 6.7 points from year to year,” where the estimated mean of the intercept factor is 80 and the estimated mean of the slope factor is 6.7.

² Different centering points allow the intercept to describe the mean value at any given time point. For example, centering at the last measurement occasion allows inferences about where individuals end up at the last time point in the study.

Growth curve models fit a trend line for each individual in the sample. These lines describe intra-individual change. Individual variation is captured by random effects (i.e., the variation in the growth factors) and is used to summarize the heterogeneity in growth of the individuals in the sample (i.e., inter-individual differences). The variance of the intercept factor describes the amount of variation of the individuals at the centering time point. The variance of the slope factor describes the amount of variation in the growth rate over the individuals. A nonsignificant variance indicates that there is not significant variation among the individuals for the given growth factor. Figure 2.1 depicts a generic path diagram for a growth curve model with a continuous outcome, Y , measured at four time points, and two continuous growth factors, the intercept, I and the slope, S . The arrows pointing into the Y 's indicate residual variance on the outcomes. The arrows pointing to the growth factors (i.e., I and S) indicate that the variances are estimated for those factors.

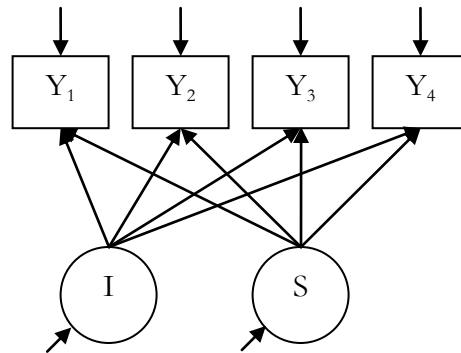

Figure 2.1. Path diagram for a general growth model.

For a general linear growth curve model, each individual's status on the outcome Y is assumed to change at a constant rate, and these rates vary randomly for the population of individuals. The outcome, Y_{it} , for person i is measured at time t , with T_i time points ($t = 1, \dots, T_i$). The simple linear growth curve model that describes individual change is

$$Y_{it} = I_i + S_i x_{it} + e_{it}, \quad e_{it} \sim N(0, \sigma^2) \quad (1)$$

where x_{it} is the time variable (e.g., age, months, grades, or years). Depending on the application, measurements for all individuals may occur at the same time (i.e., $x_{it} = x_t$ for all i), but this is not necessary. As described above, there are two parameters of individual i : I_i , the status of that person at the first time point in the study, and S_i , that person's linear rate of change per unit increase in x_{it} .

Many variations of the common growth curve exist and are able to facilitate modeling change in a range of outcomes and applications. Some extensions include models that describe curvilinear or nonlinear change, models that include predictors of inter-individual differences or predictors at higher levels of nesting (e.g., multilevel context variables), or models that include more than one growth process (e.g., parallel process growth models). Growth mixture modeling (Muthén & Shedden, 1999; Muthén et al., 2002) is a type of analysis that uses a latent class variable to capture heterogeneity in growth trajectories and is considered an advanced extension of the growth curve model.

One key feature of the growth curve model is that the repeatedly measured outcomes are related to each other through the growth factors and not directly related to each other. This is a feature that distinguishes this model from autoregressive models.

Continuous Observed Outcomes: Autoregressive Models

An autoregressive model describes change from a different perspective than a growth curve model does. Instead of using continuous growth factors and their variances to describe individual change, autoregressive models explore the time-adjacent relationships of individuals' outcomes. The main feature of these models is that an outcome is directly

related to one (or more) of the previously measured outcomes. First-order autoregressive models are those where each outcome is directly related to only the immediately previous one, implying that the correlations of outcomes decrease in magnitude as a function of the distance from the diagonal of the correlation matrix of all time points (Curran & Bollen, 2001).

An autoregressive model consists of a series of regressions, one for each time point, of the outcome on one (or more) prior outcomes of the series. A simple autoregressive model is depicted in Figure 2.2. The regression coefficients describe the direction and strength of the relationship between adjacent outcomes. These coefficients can be constrained to be equal across time, implying a stationary process. Figure 2.2 depicts a first-order autoregressive model where adjacent time points are being regressed on each other (i.e., y_2 on y_1 and y_3 on y_2 , etc.). A second-order effect would involve the regression of y_3 on y_1 , y_4 on y_2 , and so on.

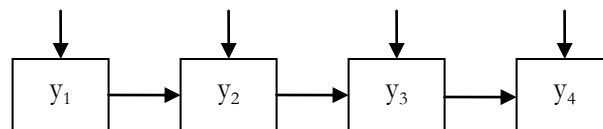

Figure 2.2. Path diagram for a generic first-order autoregressive model with continuous observed outcomes.

In autoregressive modeling, the unit of time is not explicitly included in the model. There are no assumptions about the distances between measurement occasions. Therefore, measurement occasions can be equally or variably spaced. The regression coefficients that

relate adjacent time points identify if, and to what extent, change occurred between the measurement points.

In sum, the key distinguishing feature between the growth curve model and the autoregressive model is the way the models describe the relationships of the repeatedly measured outcomes. Growth curve modeling describes relationships of the outcomes using growth factors, while autoregressive models describe the relationships through regressions of adjacent time points. For this reason, growth models are generally used when research questions focus on the average rate of change over a given time and the growth process is assumed to be continually occurring at the same rate. Autoregressive models directly describe change among time points, and are often used when change is assumed discontinuous.

Categorical Observed Outcomes: Growth Modeling

Growth modeling with categorical variables is appropriate for two types of categorical outcomes: binary and ordered polytomous. Dichotomous or binary variables arise when there are only two categories of the outcome—for example, yes/no items, or failure/success indicators. Ordinal or ordered polytomous variables exhibit an ordering among the various categories, but the distance between these categories is not specified (e.g., the difference between category 1 and 2 is not necessarily the same as the distance between categories 2 and 3). Examples of ordered polytomous variables are social class indicator variables (e.g., low, middle, and high), proficiency level variables (e.g., low, moderate, moderately high, and high), and Likert scale variables that measure agreement with an item (e.g., strongly disagree, disagree, agree, and strongly agree).

Growth modeling with categorical outcomes is driven by the assumption that there is an underlying continuous distribution for an item (denoted y^*), and that the categories of the variables are cuts in the y^* distribution (Muthén and Muthén, 2007). The growth parameters describe individual differences in the probability of being in the categories of the outcome. For more on the use of growth models that describe change in categorical outcomes, see Fitzmaurice, Laird, and Ware (2004) and Hedeker and Gibbons (1994).

Categorical Observed Outcomes: Autoregressive Models

Autoregressive models provide a natural way to describe change in categorical outcomes. Any type of categorical outcome can be used with these models because the models use conditional probabilities to describe change among the categories of the outcomes across time. The relationship between two categorical variables can be specified as a multinomial logistic regression, where the variable at time t is regressed on the variable at time $t-1$.

Consider the categorical variable, C , with K categories that is predicted by a continuous covariate, x . The multinomial logistic regression is given by the equation

$$P(C_i = k | x_i) = \frac{\exp(\alpha_k + \beta_k x_i)}{\sum_{m=1}^K \exp(\alpha_m + \beta_m x_i)}, \quad (2)$$

where the last category, K is a reference category with $\alpha_K = 0, \beta_K = 0$. The relationship described in Equation 2 includes a continuous covariate, x , but categorical covariates can also be used as predictors of C .

For applications that use categorical covariates, dummy variables (or design variables) are included in the model as indicators of the categories of the variable. For a variable that has M categories, $M-1$ dummy variables are used. Consider a categorical variable

with three categories (i.e., $M = 3$). The dummy variable d_{im} , with $m = 1, \dots, M-1$, can be used where $d_{i1} = 1$ if $c_i = 1$, denoting that an individual is in category 1 of the variable C , and $d_{i2} = 1$ if $c_i = 2$, denoting that an individual is in category 2 of the variable C . The dummy variable, d_{i3} , is not included in the model because category 3 is selected in this case as the reference category. The relationship of a categorical variable C measured at time point t , (C_t), can be predicted by a categorical variable from time point $t-1$, (C_{t-1}). Let both C_t and C_{t-1} have three categories ($k, m = 1, 2, 3$). The multinomial logistic regression of C_t on C_{t-1} is given by

$$P(C_{it} = k | C_{i(t-1)} = m) = \frac{\exp(\alpha_k + \beta_{1k}d_{i1} + \beta_{2k}d_{i2})}{\sum_{l=1}^3 \exp(\alpha_l + \beta_{1l}d_{i1} + \beta_{2l}d_{i2})}, \quad (3)$$

where $\alpha_3 = 0$, $\beta_{13} = 0$, and $\beta_{23} = 0$, because the last category is considered the reference category for standardization (Reboussin et al., 1998). The relationship of the two categorical variables in Equation 3 can be expressed in terms of each of the categories of C_{t-1} as follows

$$P(C_t = k | C_{t-1} = 1) = \frac{\exp(\alpha_k + \beta_{1k})}{\exp(\alpha_1 + \beta_{11}) + \exp(\alpha_2 + \beta_{12}) + 1}, \quad (4)$$

$$P(C_t = k | C_{t-1} = 2) = \frac{\exp(\alpha_k + \beta_{2k})}{\exp(\alpha_1 + \beta_{21}) + \exp(\alpha_2 + \beta_{22}) + 1}, \quad (5)$$

$$P(C_t = k | C_{t-1} = 3) = \frac{\exp(\alpha_k)}{\exp(\alpha_1) + \exp(\alpha_2) + 1}. \quad (6)$$

Six parameters of the multinomial logistic regression relate the two categorical variables, namely, $\alpha_1, \alpha_2, \beta_{11}, \beta_{12}, \beta_{21},$ and β_{22} . The β 's, are the logistic regression coefficients and represent the change in the logit corresponding to a change of one unit in the independent variable. When dummy variables are used, the value of the corresponding logistic regression coefficient represents the difference in the log odds of $C_t = k$ versus $C_t =$

K , between individuals belonging to the category indicated by the dummy variable compared to individuals in the reference category. This value is the natural log of the ratio of odds of $C_i = k$ (versus $C_i = K$) for belonging to the category indicated by the dummy variable compared to belonging to the reference category. The most common way of interpreting a logistic regression coefficient is to convert it to an odds ratio by taking the exponent of the coefficient (e.g., $e^{\beta_{11}}$).

It is useful to express the relationship of the two categorical variables using a transition matrix (also called a transition table), where the multinomial logistic regressions define the elements of the transition matrix. Table 2.1 presents a transition matrix that shows the relationship between two categorical variables, each with three categories. The cells of the table are expressed as conditional probabilities, values that are estimated using Equations 3 through 5.

Table 2.1. Transition matrix for two categorical variables, each with three categories

C_{t-1}	C_t		
	1	2	3
1	$P(C_t=1 C_{t-1}=1)$	$P(C_t=2 C_{t-1}=1)$	$P(C_t=3 C_{t-1}=1)$
2	$P(C_t=1 C_{t-1}=2)$	$P(C_t=2 C_{t-1}=2)$	$P(C_t=3 C_{t-1}=2)$
3	$P(C_t=1 C_{t-1}=3)$	$P(C_t=2 C_{t-1}=3)$	$P(C_t=3 C_{t-1}=3)$

Consider the transition term $P(C_t=1 | C_{t-1}=2)$ that represents the probability of being in category 1 of C_t , given membership in category 2 of C_{t-1} . Using Equation 5, this value can be expressed as follows,

$$P(C_t = 1 | C_{t-1} = 2) = \frac{\exp(\alpha_1 + \beta_{21})}{1 + \exp(\alpha_1 + \beta_{21}) + \exp(\alpha_2 + \beta_{22})} .$$

Because these multinomial logistic regressions model longitudinal data, these values are the transition probabilities. These values describe the probability of transitioning to a category at time 2, given an individual's membership in a category at time 1. Other covariates can be included in the model and are described in more detail in a later section.

Longitudinal Models with Latent Variable Outcomes

All of the models described in this chapter thus far have been concerned with observed outcomes. It is possible to use the same longitudinal models with outcomes that are not directly observed (i.e., latent variable outcomes). As with observed outcomes, latent variable outcomes can be both continuous and categorical. Latent continuous variables are usually referred to as *factors*, while latent categorical variables are usually referred to as *latent class variables*. When considering models with latent variable outcomes, the focus is no longer on the measured items but rather on the latent variables. Within the latent variable modeling framework, it is possible to have continuous or categorical measured items, or the combination of the two, as indicators of a latent variable, which may be either categorical or continuous.

Defining the Latent Variable

Most commonly, latent variables are identified by a set of items at each time point. Depression, for example, is often considered a latent variable (i.e., a depression factor) that is measured by a set of items related to depression symptomology (items such as “sleeping a lot,” “having a hard time being active,” and “feeling blue”). The use of multiple observed items requires a measurement model that relates the observed items to the latent variable (e.g., factor analysis or latent class analysis). Factor analysis is used when the latent variable is

thought to be continuous (i.e., dimensional), and latent class analysis is used when the latent variable is thought to be categorical. Other measurement models are also available and are discussed in a later section.

Continuous Latent Outcomes

Autoregressive models can describe change among latent continuous factors over time. In these models, a set of items measured repeatedly over time identify the continuous latent factor. Similar to change in continuous observed variable, the autoregressive relationship of latent variable outcomes is achieved by a set of regressions of the factors on each other. First-, second-, and higher-order relationships are possible.

Growth models that use latent continuous outcome variables are called *multiple indicator growth models* or *higher-order growth models*. These models can quickly become complex and require several measurement assumptions. Multiple indicator growth models use repeatedly measured items to identify factors over time, and growth parameters model change in the factors.

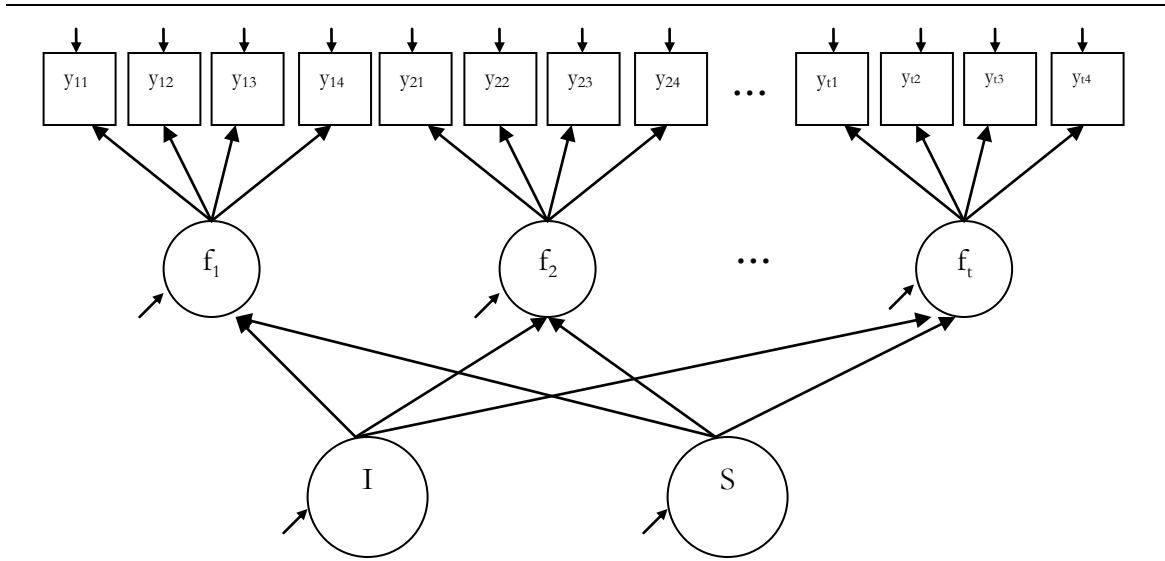

Figure 2.3. Model diagram for a multiple indicator growth model.

Figure 2.3 depicts a general multiple indicator growth model that has four items, y_{it} , that are repeatedly measured over t time points. The four items identify a continuous latent factor at each time point, f_t . The growth factors, I and S , describe change in the factors f_t over time. To assure that the growth factors are truly describing change in the factors and not just measurement differences, measurement invariance is imposed. Specifically, the factor loadings are assumed invariant across time. That way, the growth factors are describing mean shifts in the factors f_t over time.

Categorical Latent Variable Outcomes

Similar to modeling change in observed categorical variables, growth models can describe change in latent categorical variables (i.e., latent class variables) when there is an ordering to the categories. For ordered categorical variables, a higher order growth model can describe change in the categories of the latent class variables. The use of growth

modeling to describe change in latent class variables is not common, instead change in the categories is described using autoregressive models. These models are similar to those with observed variables except for the fact that these models describe change among the categories of the latent variable. This type of model is the focus of this dissertation. The LTA model is a model that can describe changes among latent categorical variables. The rest of this chapter describes the details of the specification and estimation of this model.

The Latent Transition Analysis Model

Latent transition analysis describes a type of longitudinal autoregressive model common in social science research. Examples of the application of the LTA model include testing children's drawing development and skills acquisition (Humphreys & Tanson, 2000), testing drug use onset and subsequent abuse (Graham, Collins, Wugalter, Chung & Hansen, 1991), and studying of the progression of health-risk behaviors in youth (Reboussin, Reboussin, Liang, and Anthony, 1998).

LTA has its roots in latent class theory as presented by Lazarsfeld and Henry (1968) and Wiggins (1973). The outcome variable in LTA is a latent categorical variable captured using a measurement model, which is most commonly a latent class analysis (LCA) model. The LTA model considered in this dissertation is specified in the latent variable framework of Mplus (Muthén, 2002; Muthén & Muthén, 1998-2007). Within this framework, many modeling extensions are possible, some of which are highlighted in this dissertation.

It is important to note that the LTA model describes a type of autoregressive model common in social science applications. Researchers in other disciplines use methods that explore change using similar, if not identical, models. However, these models go by different

names. Markov modeling (named after Andrey Markov) is a general name for models that describe transitions among states over time. Variants of the Markov model include models that do not assume perfect measurement in the outcomes and those that allow for a higher-order population for which there are different transition probabilities. The latent Markov model (Baum, Petrie, Soules, & Weiss, 1970; Vermunt, Langeheine, and Böckenholt, 1999; Wiggins, 1973) is another name for the latent transition analysis model described in this dissertation.

The LTA model combines the cross-sectional measurement of categorical latent variables and the longitudinal description of change in the categories of the latent variable over time. Because of this, this chapter's presentation of LTA begins by describing latent class analysis and then shows how LTA builds on the LCA measurement model. The description focuses on LCA as a measurement model because LCA is the most common measurement models for LTA applications. However, descriptions of other measurement models are also included. After describing the measurement model alternatives and details regarding selection of the appropriate model, the remainder of the chapter focuses on the LTA model specifications.

Latent Class Analysis (LCA)

LCA has a rich history outside of LTA as a cross-sectional data analysis technique frequently used in applied research. Conceptually similar to factor analysis, LCA uses an underlying latent variable to describe the relationship among a set of observed items. The distinguishing feature of LCA is that the underlying latent variable is categorical, and its manifest variables (indicators) are categorical. Lazarsfeld and Henry (1968) introduced the LCA model as a way to categorize individuals into classes (sometimes referred to as latent

groups, states, or statuses) based on a series of measured dichotomous survey items. Since its introduction, the LCA model has been applied to many substantive research areas as a way of capturing unobserved heterogeneity in a population.

Classical LCA models only used categorical observed items (e.g., binary, ordered, or unordered polytomous variables). However, with advances in the statistical algorithms used to estimate these models and their implementation in more statistical software packages, it is possible for LCA models to have any type of outcome (e.g., binary, ordinal, nominal, count, and continuous) or any combination of them. Some researchers use the term *latent profile analysis* (LPA) to describe LCA with continuous outcomes.³ For more on the application of LCA models with continuous outcomes see Vermunt (2004). For more information on the collection of possible outcomes and their combination for the LCA models available in Mplus, see Muthén (2006) and Muthén and Muthén (2007).

LCA Model Parameters

There are two types of LCA model parameters: *item probability parameters* and *class probability parameters*. For LCA models with binary outcomes, the item parameters correspond to the conditional item probabilities, i.e., item probabilities conditional on latent class membership. Each item probability parameter contains information on the probability that an individual in a given latent class has of endorsing the item. The class probability parameters specify the prevalence of each class in the population (i.e., relative frequency of class membership).

³ This dissertation considers LCA models with observed categorical outcomes. Thus, from this point on, the model parameters discussed only pertain to LCA models with categorical outcomes.

The LCA model with p observed binary items, u , has a categorical latent variable C with K classes ($C = k; k = 1, 2, \dots, K$). The marginal item probability for item $u_j = 1$ ($j = 1, 2, \dots, p$) is given by

$$P(u_j = 1) = \sum_{k=1}^K P(C = k)P(u_j = 1|C = k), \quad (7)$$

where the conditional item probability in a given class is defined by the logistic regression

$$P(u_j = 1|C = k) = \frac{1}{1 + \exp(-v_{jk})}, \quad (8)$$

where the v_{jk} is the logit for each of the u_j 's for each of the latent classes, k . The class prevalence is $\delta_k = P(C = k)$. Assuming conditional independence of the u 's within class, the joint probability of all the p observed items is given by

$$\begin{aligned} P(u_1, u_2, \dots, u_p) &= \sum_{k=1}^K P(C = k)P(u_1, u_2, \dots, u_p | C = k) \\ &= \sum_{k=1}^K P(C = k)P(u_1|C = k)P(u_2|C = k)\dots P(u_p|C = k). \end{aligned} \quad (9)$$

Figure 2.4 presents the path diagram of the general latent class model. Variables in boxes represent measured outcomes, u . The circled variable represents the unordered latent class variable, C , with K categories. The conditional independence assumption for LCA models imply that the correlation among the u 's is fully explained by the latent class variable, C . Thus, there is no residual covariance among the u 's.

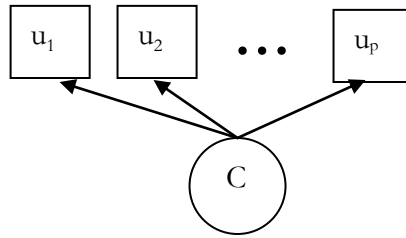

Figure 2.4. General latent class analysis diagram.

Conditional item probabilities are important model parameters because they are used to attach substantive meanings to each class. These values are plotted in an item probability plot, as depicted in Figure 2.5, to aid in the interpretation of the latent classes. Along the x -axis are the observed items, while the y -axis displays the conditional item probabilities for each of the classes. Figure 2.5 displays two items probability plots for an example LCA solution with two classes measured by five observed items. The panel on the left of Figure 2.5 is an example of an *ordered solution* and the example on the right is an example of an *unordered solution*.

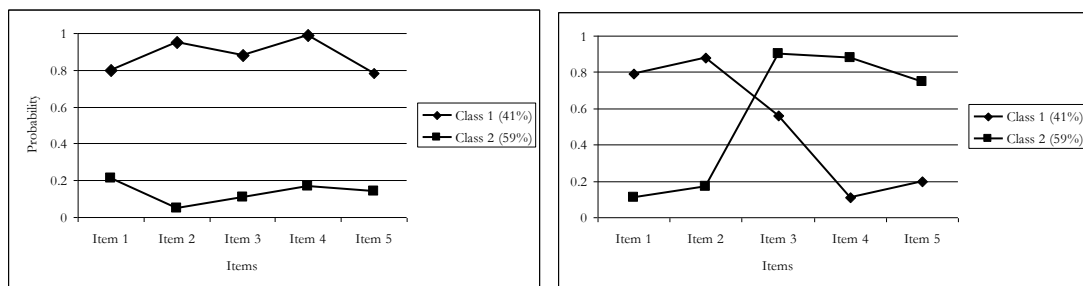

Figure 2.5 Item probability plots for ordered (left) and unordered (right) LCA solution with binary outcomes.

The panel on the left in Figure 2.5 displays two profiles that do not cross. The top profile (Class 1) is characterized by having a relatively high probability of endorsing all the

items while the lower profile (Class 2) is characterized by having a low probability of endorsing all the items. This is considered an ordered solution because the profiles do not cross. For example, if the 2-class solution on the left had items that measured violence exposures, Class 1 would be interpreted as the “high exposure” class and Class 2 as the “low exposure” class.

The right panel in Figure 2.5 is an example of an unordered latent class solution where the class profiles cross each other. This contrasts the solution on the left where classes are either high or low across *all* the measured items. The profiles in the right panel of Figure 2.5 show that items 1, 2, 4, and 5 are significant in differentiating the two profiles. Using the violence exposure example from before: if items 1 and 2 were community violence items, Class 1 would be interpreted as a “community violence exposure” class because the class is characterized by having a high probability of endorsing the first two items but not the other items. If items 4 and 5 measured exposure to peer violence, Class 2 would be the “peer violence exposure” class because individuals in this class have a high probability of endorsing the peer violence items but not the rest of the items.

Item probability plots display the conditional probabilities and are helpful for inspecting the profiles of the latent classes. The actual values of the conditional probabilities are often displayed in tables. The relative frequencies of the latent classes are denoted by the class prevalence parameters, δ_k . These parameters describe the relative frequency or proportion for the classes at each time point. These values are often displayed in the legends of the item probability plots, as seen in the two plots found in Figure 2.6.

After an LCA model is fit, posterior class probabilities can be estimated. Posterior probabilities are similar to the estimates of factor scores once a factor analysis model has been fit.⁴ Posterior class probabilities values that indicate the individual's probabilities of being in each of the latent classes of the fitted model, given the individuals' observed response pattern on the measured items. The probabilities are a function of the model's parameters (i.e., the estimated item probabilities and the estimated prevalence of each latent class). Each individual can be assigned to the latent class for which they have the highest posterior probability of membership. For example, consider an individual that has posterior probabilities of being in the three classes of 0.80, 0.15, and 0.05 for Classes 1, 2, and 3, respectively. This individual would be assigned to Class 1 because that is where the highest posterior probability is observed. The process of assigning individuals to one of the latent class is referred to as modal class assignment.

The LTA Model

As described above, the LTA model builds on the LCA measurement model. Figure 2.6 depicts how the LTA model relates the latent class variables at different time points to each other using an autoregressive relationship. The LTA model presented in Figure 2.6 displays a three-time point diagram of an LTA model. With multiple time points, the same p items are repeatedly measured, necessitating an additional index that denotes the measurement occasion. As a result, there is an additional subscript t on the items when they are discussed in a longitudinal setting.

⁴ In Mplus, posterior probabilities can be saved to an external data file using the "SAVEDATA" command and specifying "save = cprobabilities".

The LTA model depicted in Figure 2.6 uses three time points, thus $t = 3$. The three binary outcomes u_{ij} , ($j = 1, 2, 3$) are measured at each of the three time points. The outcomes are used as indicators of the categorical latent class variables at each time point, C_t , that has K classes, where there are three classes at each time point (i.e., $K=3$ for all t).

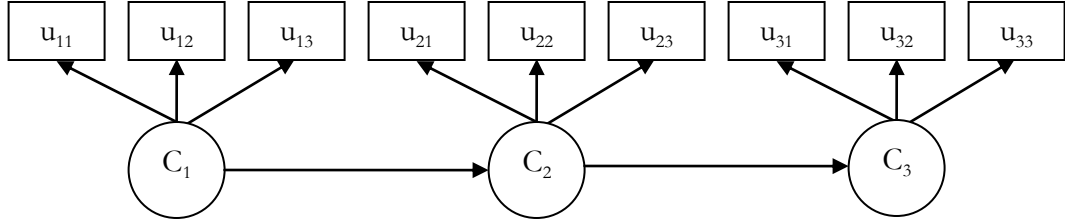

Figure 2.6. A latent transition model diagram with three observed binary variables and three measurement points.

There are $t-1$ transition points for any LTA model. For the LTA model depicted in Figure 2.6, the latent class variable for time point t is regressed on the latent class variable at time point $t-1$ (i.e., C_2 on C_1 , and C_3 on C_2). The autoregressive relationship of the latent class variables over time is similar to the relationship of the categorical observed variables in Equation 2 for observed variables. Instead of the C 's representing observed categorical variables, in the LTA setting they represent the prior latent class variables. The relationship of the latent class variables can be expressed using Equation 3,

$$\tau_{ikm} = P(C_{it} = k | C_{i(t-1)} = m) = \frac{\exp(\alpha_k + \beta_{1k}d_{i1} + \beta_{2k}d_{i2})}{\sum_{q=1}^3 \exp(\alpha_q + \beta_{1q}d_{i1} + \beta_{2q}d_{i2})},$$

where τ_{ikm} is the transition probability for individual i to be in latent class k at time point t , given that the individual was in latent class m at the preceding time point, $t - 1$. The odds ratio is given by $\exp(\beta_{mk})$ and is the ratio of the odds of being in class k at time t versus

Class 3 (the reference class) for those who were in class m at the previous time point ($t-1$), compared to those who were in Class 3 (i.e., the reference class) at the previous time point.

When covariates are included in the LTA model, the transition probabilities are no longer conditioned only on the previous time point, but also on the values of the covariates. Consider an example where a binary indicator of gender (male = 0, female = 1) is included in the LTA model. A transition probability is given by the following equation

$$\tau_{ikm} = \frac{\exp(\alpha_k + \beta_{mk} + \gamma_k(\text{female}_i))}{\exp(\alpha_1 + \beta_{m1} + \gamma_1(\text{female}_i)) + \exp(\alpha_2 + \beta_{m2} + \gamma_2(\text{female}_i)) + 1}. \quad (10)$$

Equation 10 shows that when the value of the gender indicator takes on the value of one, there is an additional term, $\gamma_k(\text{female}_i)$, in the model that changes the value of the transition probabilities. The logistic coefficient γ_k describes the change in the log odds (i.e., increase or decrease depending on the sign of the coefficient) for female students, as compared to male students, of being in class k compared to Class 3 (the reference class) at time point t . The odds ratio for being Class 1 versus Class 3 when comparing females to males would be $\exp(\gamma_k)$.

In a model with three classes, there will be two logistic regression coefficients for gender at each time point: one for Class 1 (γ_1) and one for Class 2 (γ_2). Suppose an estimate of $\gamma_1 = -0.25$ is obtained. This would be interpreted in the following way: Being female instead of male decreased the log odds of being in Class 1 relative to Class 3. This implies that the odds ratio for being in Class 1 versus Class 3 when comparing females to males is $0.77 (e^{-0.25})$.

Measurement Model Specification

As previously mentioned, LCA is the most commonly used measurement model in applications of LTA. Several important details involving the LCA model are highlighted in the following sections. These include decisions regarding the number of latent classes and how to determine if measurement invariance is reasonable for this application.

Deciding on the Number of Classes in LCA

Thus far, the number of latent classes has been discussed as if the number was a known quantity. In most applications of LCA, however, the number of classes is not known. The process of deciding on the number of classes that sufficiently describes the heterogeneity in a set of items involves fitting a series of LCA models. This process usually begins by specifying a 2-class LCA model and then increasing the number of classes until the models no longer converge or the results of the models are nonsensical. The fit of each of the models considered is compared and used to determine the number of classes that provides the most meaningful and statistically-sound results.

LCA is a type of mixture model. Mixture models (also called finite mixture models) characterize and parameterize heterogeneity based on the idea that the overall population results from a *mixing* of more than one characteristically different sub-populations, where the subpopulations are not directly observable. Latent classes identify the latent subgroups in the population. The researcher must determine, using statistical indices and the interpretability of the results, how many latent classes (i.e., latent subpopulations) exist in the population; or, at least, how many latent classes are needed to fully capture the population's heterogeneity.

In the literature, there is no one single statistical indicator commonly accepted for use in determining the appropriate number of classes for a given population in mixture models. Even though LCA models provide a log likelihood value for a given estimated model and dataset, the likelihood value cannot be used in traditional ways to compare nested models. LCA models that differ by one class (e.g., a $(k-1)$ class model and a (k) class model) are in fact nested LCA models, but traditional likelihood ratio testing (LRT; see, for example, Bollen, 1989) is not applicable because necessary statistical properties are not met.⁵

As an alternative, other statistical indices can aid in the decision on the number of classes. An alternative likelihood-based test called the bootstrap likelihood ratio test (BLRT; see McLachlan & Peel, 2000) can be used. This test uses a bootstrapped sample to estimate the log likelihood difference distribution of the two nested LCA models, for example a $k-1$ and a k -class model. The significance of the BLRT p -value is used to assess if there is a significant improvement in fit between models that differ in the number of classes.⁶ In Mplus, the BLRT explores the change in fit between the $k-1$ and k -class models but, in general, the BLRT can test $k-g$ versus k -class models, where $g < k$. For example, for a model that was specified as a 4-class LCA, the BLRT p -value compares the fit between the 3- and 4-class models. A significant BLRT p -value would indicate a significant improvement in fit with the inclusion of a fourth class compared to the 3-class model. A nonsignificant BLRT p -value would indicate that the 4-class model does not provides a significantly better fit when compared to the 3-class model.

⁵ The LRT is not applicable for nested LCA models because the $k-1$ class solution is a special case of the k -class solution, where the probability of one of the class is set to 0. A probability that is set to zero is fixing a parameter at the border of its parameters space, which results in the difference of the log likelihoods not being chi-square distributed.

⁶ The BLRT is available in Mplus by requesting "TECH14."

Information criteria (IC) can compare fit for a set of fitted models. ICs are fit indices based on the log likelihood value of a model with an added penalty that varies across the different ICs (e.g., a penalty for small sample size or large number of parameters in the model). The idea is that, all other things being equal, for two models that have equal log likelihoods, the model with the fewest parameters and larger sample size is better. The value of the ICs can compare model fit across a range of models, where the lowest value of a given IC among those considered identifies the preferred model. The commonly used ICs for LCA class enumeration are the Bayesian Information Criterion (BIC; Schwartz, 1978) and the Adjusted BIC (ABIC; Sclove, 1987). The BIC applies a penalty for the number of parameters (g) and the sample size, and is defined as

$$BIC = -2 \log L + g \log(n).$$

The ABIC changes the penalty by adjusting the sample size n , such that models with larger sample sizes receive a smaller penalty. The ABIC replaces the sample size n in the BIC equation above with n^* ,

$$n^* = (n+2)/24.$$

A recent simulation study by Nylund, Asparouhov, and Muthén (in press) indicated that the BLRT and the BIC are the best and most consistent statistical indicators for use in determining the number of classes in LCA models.

Taken together, the BIC and BLRT are statistical indicators that can aid in a decision on the number of classes needed in an application of LCA. It is also important, however, to consider the interpretability of the classes provided by the solution. It is possible that the statistical indices point to a solution that does not make any substantive sense and may not

be a useful model for describing the heterogeneity in the population. Both statistical and practical considerations need to be considered when deciding on the number of classes.

Selection of the Measurement Model

Most applications of LTA use LCA as the measurement model that identifies the categories of the latent variable. This is a natural choice because LTA is often considered a longitudinal extension of LCA. For applications that only consider the LCA model as a possible measurement model, the only necessary decision is how many classes are needed for the latent class variable. When LTA is specified in a more general latent variable modeling framework, however, a richer array of measurement models becomes available. Thus, there are two decisions to be made: (a) which type of latent variable model to use and (b) how many classes are necessary at each of the time points.

Measurement models considered in this dissertation include standard latent class models and more advanced hybrid models. The available models include continuous and categorical latent variables, as well as the combination of the two. Specifically, the measurement models considered are as follows: factor analysis (FA),⁷ latent class analysis (LCA), latent class factor analysis (LCFA), and factor mixture analysis (FMA).

Factor Analysis is a latent variable technique that assumes the underlying latent variable has a continuous normal distribution. LCFA and FMA have both continuous and categorical latent variables. Because they contain both types of latent variables, LCFA and FMA are considered *hybrid* models. LCFA is a more restricted type of hybrid model that can

⁷ Factor Analysis is considered as a possible measurement model. If it is determined that a factor analysis model is an appropriate measurement model, the relationships among factors over time would not be modeled using LTA, and a standard autoregressive model would be used to model the relationship over time. This is because factors are continuous latent variables and LTA models change among categorical latent variables.

be used to describe non-normal factor distributions. In LCFA, latent classes act as support points for the distribution, and there is no within-class variation of the factor. For example, in the application to peer victimization data, LCFA can describe the distribution of peer victimization in such a way that would allow for a non-normal distribution. The classes could identify key distributional points, such as classes of individuals at the high, medium, and low ends of a peer victimization continuum.

FMA is another type of hybrid latent variable model. However, it is a more flexible, and thus a more general, hybrid model than the LCFA model. FMA models have both continuous and categorical variables. Different from LCFA, the FMA model allows for within-class variation of the factor(s). There are several different specifications of the FMA model. For example, FMA models can be specified with or without invariance of the measurement parameters across classes for the factors. Further, models can have different numbers of factors within the latent class classes. For more on these models and the comparisons to other techniques, see Lubke and Muthén (2005), Muthén (2006), and Muthén and Asparouhov (2006).

Comparing the Fit of Measurement Models

For applications that consider more than one type of measurement model, the first decision is to determine which *type* of model to use at each time point. Because a range of measurement models can be considered at each time point in the analysis, a selection method is necessary to decide which model is most appropriate for the given application. This decision is made for each time point in the analysis.

In this dissertation, the following comparison strategy was used to compare relative fit for the measurement models considered. For each type of model considered (i.e., FA,

LCA, LCFA, and FMA), several differently specified models were considered. For example, for the LCA model, it is likely that 2-, 3- or 4-classes may be considered. Fit information is collected for each model considered and compared to other models within the same type. Fit information that can be used to compare fit includes the log likelihood value, the number of parameters the model estimates, the BIC, and when appropriate, the BLRT p -value (BLRT can be used for LCA models).

The model that provides the best fit for each type (i.e., best fitting LCA model, best fitting LCFA, etc.) is selected using the available statistical indicators. Then, the selected models for each type are compared across model types to decide which model should be the measurement model for the given time point. If there is no clearly superior model for a given time point, this is noted and compared to the results from the other time points. This assesses if there is consistency across time points that can aid in the decision process. It is not necessary to have the same measurement model across time. When possible, however, having the same measurement model across all time points is helpful in making the model specification and interpretation more straightforward.

Measurement Invariance

If the same measurement model is used across all time points (e.g., LCA) and the same number and type of classes are used, it is reasonable to explore measurement invariance. Measurement invariance assumes the equality of the parameters of the measurement model, specifically conditional item probabilities for LCA variables, and the factor loadings for factors. In the LTA model that uses LCA, the measurement parameters are the conditional item probabilities estimated for each class at the different time points. Three levels of measurement invariance are possible: full invariance, partial invariance, and

full noninvariance. Full measurement invariance implies that the conditional item probabilities are invariant (i.e., the same) across all the different time points. This means that the same number and type of classes occur at all time points. As a result, the interpretation of the transition probabilities is straightforward since the meanings of the classes are the same across time. When the latent class solutions have the same number of classes and the profiles of the classes look alike across time, measurement invariance may be a plausible assumption. Full measurement noninvariance imposes no constraints on the measurement parameters across time.

Partial measurement invariance involves equality constraints for some of the measurement parameters across time, while the rest are unconstrained. A series of partial measurement invariance strategies can be specified, ranging from equality constraints on the item probabilities for a single item across time within a specific class, to all items within a class being invariant across time. There is a large number of possible invariance specifications. Consider a 3-time point LTA model where at each time point there are four observed items. If the LCA model identified three latent classes, there are 36 measurement parameters (4 items x 3 classes x 3 time points). A range of parameter constraint combinations is available for the partial measurement constraints.

The model with full measurement noninvariance makes no assumptions about the equality of the measurement parameters. That is, all measurement parameters are freely estimated across classes and across time. Full noninvariance is the most flexible invariance strategy, but as a result, often involves the estimation of a large number of measurement parameters. Full measurement noninvariance is most practical when there are few time

points, the resulting classes appear to be different across time, or there are a different number of classes across time.

Assuming measurement invariance significantly reduces the number of parameters and makes interpreting model parameters straightforward. It is possible, however, that the latent classes vary in interesting ways over time. Full measurement invariance may not be plausible, depending on the nature of the latent classes that emerge, the items that measure them, and the time spanned by the measurements. For example, for an application using an LCA measurement model, it may be developmentally relevant to have two classes measuring violence exposure in adolescents; but by the teenage years, four or five classes may be needed to adequately describe heterogeneity in violence exposure. In this case, the number of classes increases in a developmentally relevant way because there is more diversity in violence exposure as individual's age due to increasing variability in neighborhood and lifestyles. With models that differ in the number of classes across time, it is possible that one class remains consistent over time (i.e., a normative class). Therefore, it may be reasonable to explore partial measurement invariance where this class is invariant across time and no restrictions are put on the other classes.

Measurement invariance is a model specification that varies according to the dataset and variables used in each application. There may be theoretical and conceptual reasons why full invariance or full noninvariance may be reasonable or needed. Analytic or computational reasons may dictate some level of measurement invariance. Each application of the LTA model requires an exploration of measurement invariance that considers these ideas.

Statistical tests in the form of log likelihood ratio tests (LRTs) can assess if significant differences in fit exist using models that impose different invariance strategies. For LTA

models where the same number and type of classes emerge at the different time points, a full measurement invariance model can be fit and then compared to other models with less restrictive invariance assumptions. Issues of measurement invariance should be explored allowing the variables to correlate. That is, measurement invariance is tested before the relationships of the latent variables are specified, specifically in how the latent variables relate to each other longitudinally (i.e., the autoregressive relationship).

LTA Model Specification

This section describes specifications that build on the basic LTA model as introduced above. There are many complex model LTA specifications, only some of which are considered here. The specifications discussed in this chapter highlight the specifications considered in the application of LTA to peer victimization in Chapter 3. Other model extensions and specifications not included here are discussed in Chapter 4. The following section explores issues related to higher-order effects, transition probability restrictions, covariates, and distal outcomes.

Higher-Order Effects

Higher-order effects are specifications that can capture the time-dependent relationships of the latent variables. Many applications of the LTA model assume a first-order effect (i.e., lag-1 effects), as depicted in Figure 2.6. It is useful to consider higher-order effects, especially because they may provide a richer look at development than first-order effects could. The higher-order effects allow the exploration of the lasting direct effects being a member of a given class has on later class membership.

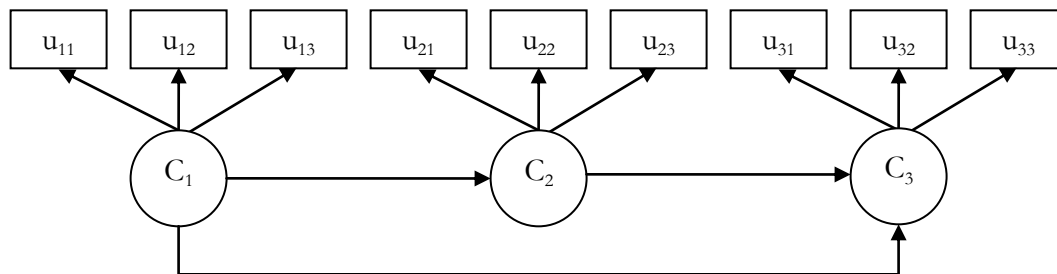

Figure 2.7. A latent transition model diagram with three observed binary variables and three measurement points, including a first- and second-order effect.

Figure 2.7 depicts a higher-order effect that is possible when three time points are used in the LTA. The arrow connecting C_3 to C_1 represents a higher-order effect, specifically a second-order effect. As depicted in Figure 2.7, even with higher-order effect, the first-order model is still included. Without a higher-order effect, C_1 influences C_3 indirectly through C_2 (i.e., the first-order effects). When the higher-order effect is included, C_1 influences C_3 directly as well as indirectly through C_2 . The higher-order effect can detect if there is a direct relationship of C_3 on C_1 , over and above the first-order indirect effect. LTA models that use more than three time points can have second-, third-, and even higher-order effects, depending on the number of time points.

Transition Probability Restrictions

Restrictions on the transition probabilities allow developmental theory to be directly included in the LTA model. As noted, transition probabilities are based on the model parameter estimates using Equation 11. Using these values, transition probabilities can be fixed to a specific value in ways that are meaningful to the given application.

Stationary transitions imply that transition probabilities are the same across transition points. A stationary change process implies that individuals are transitioning between the latent classes with the same probabilities across all transition points. To test whether stationary transition probabilities are applicable, a LRT comparison of a model that assumes stationarity and one that does not can be made. As with measurement invariance, stationary transition probabilities reduce the number of estimated parameters, but may mask important developmental changes if stationarity is a misspecification.

It is important to note that when covariates are included in the LTA model and related to the latent class variables, stationarity is no longer meaningful and should not be imposed. Using the multinomial logistic regressions, an individual's current class membership is predicted by class membership from the previous time point. When covariates are included, current class membership is predicted by both class membership at the previous time point and the value of the covariates. If stationarity were imposed, the coefficient for the dummy variable indicating previous class membership would be held equal across the different transition points. If there were any important differences in those coefficients, the effect of those differences would bias the estimation of the covariate coefficients.

Specifying an absorbing class (called an *absorbing* state in the Markov literature) is another type of restriction possible using the transition probabilities. An absorbing class is one that has a zero probability of exiting. For example, the use of LTA for survival analysis as seen in Masyn (in press) involves an absorbing state, where absorbing class is the post-event state since once an individual has experienced the event (i.e., the event of death or first

pregnancy), she forever remain in the post-event state. Thus, individuals in the absorbing state cannot transition to a state of not having experienced the event.

Another example of a developmentally relevant restriction on the transition probabilities has to do with restricted movement among the latent classes. For example, consider an LTA model that explores drug use experimentation. If one of the classes identified individuals who had not yet tried drugs, after first experimentation, an individual could never transition back into the class indicating non-experimentation. Thus, the transition probability for individual to transition back into the non-experimentation class from an experimentation class is zero.

Constraining the cells of the transition matrix to 0 or 1 involves fixing the values of the multinomial regression so that the value of the transition probability is the desired value. Masyn (in press) clearly describes how this can be done using the six parameters of the multinomial logistic regression found in Equation 11, so that the parameters properly correspond to the fixed probabilities in the transition matrix, e.g., $\tau_{21} = 1$. Because the multinomial logistic regressions use the logit link function to relate the event state in time t to the event state in time $t-1$, it is possible to approximate probabilities of 0 and 1 to any degree of precision. Consider the transition probability, τ_{13} , and say that the developmental theory suggests that that value should be fixed to 0. Thus,

$$\tau_{13} = \frac{\exp(\alpha_1)}{\exp(\alpha_1) + \exp(\alpha_2) + 1} = 0.$$

The goal is to determine which values to fix the parameters at so the resulting probability will be 0. For this transition probability to equal 0, the denominator needs to be very large, so the ratio of the numerator and denominator approximates 0. The value of $\exp(\alpha_i)$ will

become very small when α_i is small (that is, a large and negative number). Further, because $\exp(\alpha_i)$ and $\exp(\alpha_2)$ will always be greater than 0, the denominator will always be greater than 1. We can choose a value for α_i that is sufficiently small so that, regardless of the value of α_2 , the quantity will approximate 0, say $\alpha_i = -15$. Then

$$\tau_{13} = \frac{\exp(-15)}{1 + \exp(-15) + \exp(\alpha_2)} = \frac{3.05 \cdot 10^{-7}}{1 + (3.05 \cdot 10^{-7}) + \exp(\alpha_2)} \approx 0.$$

Using the same strategy, the remaining parameters of the logistic regressions can be used to fix other values of the transition matrix at desired values. For transition probabilities that involve both α and β parameters, values of both must be considered to ensure the resulting transition probabilities are fixed at the desired values.

Longitudinal Guttman Simplex

In some applications of the LTA model, developmental theory can be used to restrict the model in ways that follow what is called a Longitudinal Guttman Simplex (LGS; Collins & Cliff, 1990). The LGS assumes a monotonic change process and cumulative growth states. This implies that skills or observed behaviors at one time point build on the skills or behaviors exhibited during the previous time points. In the applications that use the LGS, substantive theory about the developmental process restricts the transition model by eliminating specific transitions.

Consider the hypothetical example of math skill acquisition in the context of children's development. An LGS learning process would imply that a student must know how to add before subtracting, how to subtract before multiplying, and how to multiply before dividing. Thus, the learning of new skills has a known pattern where one skill builds

upon the next. As a result of this simplex, which assumes an ordering in the way children acquire math skills, it is not possible for a student to know how to divide without subtracting, or know how to multiply without first knowing how to both add and subtract, and so on. The transition table for this process would have several restricted transition probabilities. For example, in Table 2.2 certain transition probabilities are fixed at 0 while others are freely estimated (denoted by a “*” in the table). For instance, the probability that a student is in the addition class and transitions into the multiplication class is 0, because the simplex assumes that a student must know subtraction before transitioning into knowing multiplication.

It is possible to specify any type of restrictions on the transition matrix. For example, the developmental theory of math skill acquisition could allow more than one skill to be learned between measurement occasions (i.e., learn both subtraction and multiplication between grades 3 and 4). This would imply that the transition probability allowing a student to transition from the addition class in grade 3 to the multiplication class in grade 4 would be freely estimated (thus that transition would be “*” instead of 0 as in Table 2.2).

Table 2.2. Example transition probabilities for an LTA model following a Longitudinal Guttman Simplex of using the math-skill acquisition example. Transition probabilities either are fixed at zero (0) or are freely estimated (*).

		Grade 4			
Grade 3	Addition	Subtraction	Multiplication	Division	
Addition	*	*	0	0	
Subtraction	0	*	*	0	
Multiplication	0	0	*	*	
Division	0	0	0	*	

The LGS approach simplifies both the measurement model and transition model. Using the LGS in this example, four binary items indicate if the developmental skills are observed (e.g., knows how to add, knows subtraction, and knows how to multiply). Because of this, the underlying categorical latent variable becomes an indicator variable, which simply identifies which pattern of the observed variables has been experienced for a given individual. There are a limited number of possible patterns, all of which may be observed in the data. The latent variable indicates particular item patterns and is a confirmatory use of LCA as a measurement model.

While the LGS approach for modeling change may be particularly relevant for testing specific stage-developmental hypotheses and is helpful in simplifying the measurement model, there are many settings where it is not appropriate. Specifically, this simplex is not applicable when change is not monotonic, when multiple indicators are used to identify each state, or when the states are not combinations of binary indicators and not known ahead of time.

Covariates and Distal Outcomes

The inclusion of covariates in the LTA model will, and should, change the estimation of the LTA model parameters. It would not be a surprise if the class profiles, class sizes, and transition probabilities change to some extent when covariates are included. As described before, when covariates are included in an LTA model and are related to the latent class variable, the transition probabilities change as a function of the value of the covariates.

Observed covariates. Within the latent variable framework, covariates and distal outcomes are easily included in the LTA model. Covariates can be related directly to the

latent class variable or can be included to see if there are differential transition probabilities as a function of the covariates. Different covariates are possible and include continuous and categorical covariates, and time-invariant and time-varying covariates. Time-invariant covariates are often background variables, such as gender or ethnicity, and are variables that capture individual characteristics. The values of these variables are treated as constant over time, even if measured repeatedly. Time-varying covariates are variables measured repeatedly, usually at the same time as the outcome indicators. The time-varying covariates are variables whose values may change as time progresses (e.g., students' feelings of depressive feelings or social anxiety), and are variables whose relationships to the outcome are of interest. Both time-invariant and time-varying covariates can be included in the model and allowed to have time-invariant or time-varying relationships with the outcome.

Figure 2.8 displays an LTA model that includes both a time-invariant covariate (i.e., gender) and a time-varying covariate (i.e., depression). In Figure 2.8, gender is included in a first-order LTA model and is related to the latent class variable at each of the three time points (C_1 , C_2 , and C_3). The relationship between gender and the three latent class variables could be modeled as having the same effect on the latent classes over time (i.e., time-invariant effect), or a different effect could be estimated for each latent class variable (i.e., time-varying effect). A time-invariant effect of gender would imply that the regression coefficients of C_1 , C_2 , and C_3 on gender would be the same (i.e., the value of γ would be the same across the C 's). A time-varying effect of gender would allow the values of the regression coefficients relating the C 's to gender to be different (i.e., a different value of γ would be estimated for each time point).

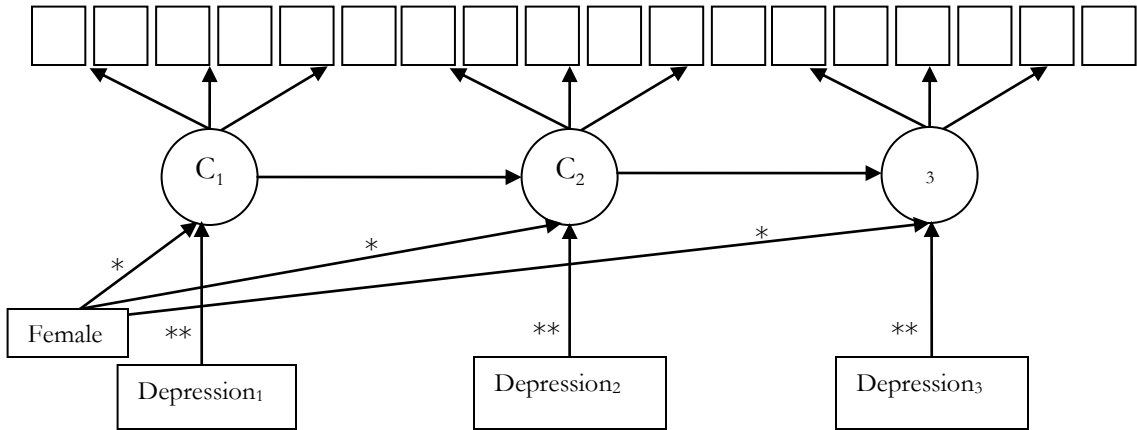

Figure 2.8. Model diagram of an LTA model with a time-invariant covariate (gender) and a time-varying covariate (depression).

In Figure 2.8, the time-varying covariate of depression has a subscript to denote the time point for which the variable is measured, which in this example is at the same time point as the outcome variables. Similar to the gender variable, the relationship between depression and the latent classes can have a time-invariant or time-varying effect. A time-varying effect of depression would allow for the exploration of the differential odds across time of being in the latent classes based on individuals' depression score. Model testing (e.g., using LRT's) can be used to determine if a time-varying effect of a covariate is appropriate for a given application.

Latent covariates are also possible and can be incorporated in the model in the form of a higher-order latent class variable. As depicted in Figure 2.9, a higher-order latent variable, C , is related to the latent class variables at each time point. Different from latent class variables used at each of the time points, the higher-order latent class variable is usually specified with a predetermined number of classes. Transition probability restrictions can be

imposed for each of the classes of the higher-order latent class variable to identify specific classes of individuals based on transitions.

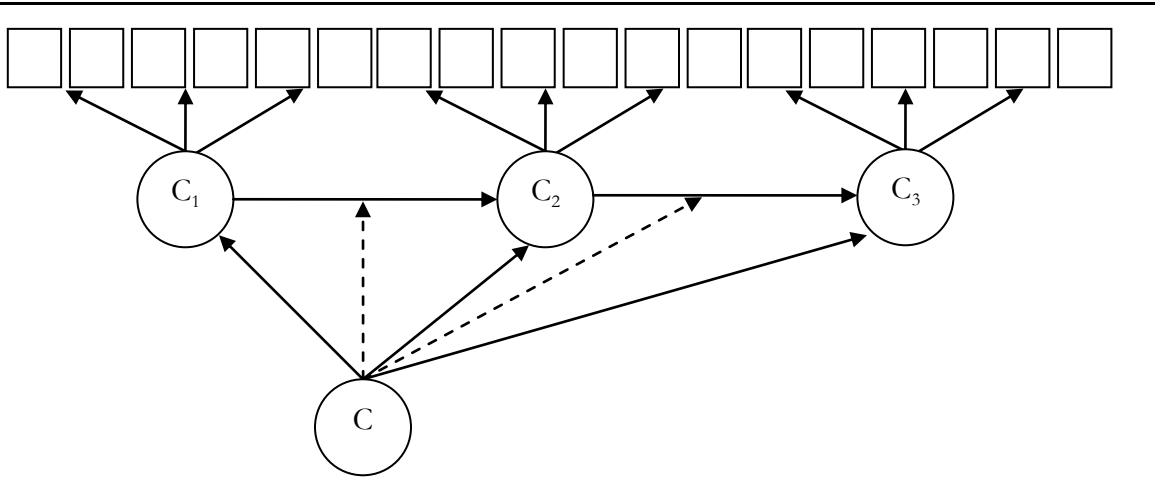

Figure 2.9. Model diagram of the LTA model with a higher-order latent class variable, C .

One specification of the higher-order latent class covariate involves two classes defined as “movers” and “stayers” (see, e.g., Langeheine & Van de Pol, 1994). In the mover-stayer model, the two classes of the higher-order latent variable identify two types of individuals based on their transition probabilities: (a) individuals who transition among the classes--the movers and (b) individuals who remain in the same class across time--the stayers. The class of movers has an unrestricted transition matrix where each transition probability is freely estimated using the multinomial logistic regression relationships described before. The stayers have a strict transition matrix, where the diagonal values are fixed to 1 and all off-diagonal values are fixed at 0. Table 2.3 presents two transition tables that could be observed for the movers and stayers. The specification of the mover-stayer higher-order latent class variable is only meaningful when the number and type of classes are the same across time (i.e., full measurement invariance). Otherwise, the interpretation of the stayers may not be

meaningful, because without measurement invariance there is no guarantee that the classes are the same across time (e.g., Class 3 of C_1 may not be the same as Class 3 of C_2).

Table 2.3. Transition probabilities for movers (left panel) and stayers (right panel)

		Movers			Stayers				
		C_2			C_2				
		1	2	3			1	2	3
C_1	1	0.50	0.20	0.30	C_1	1	1	0	0
	2	0.10	0.60	0.30		2	0	1	0
	3	0.40	0.40	0.20		3	0	0	1

The restrictions on the transition probabilities for the stayer class of the higher-order latent class variable are achieved by fixing the values of Equation 10 so that the resulting transition matrix is an identity matrix. Other restrictions on the transition probabilities for the classes of the higher-order latent class variable are possible.

Distal outcomes are variables measured after the period considered by the longitudinal model. For example, in a study using middle school outcomes, a distal outcome could be an outcome measured in high school. Distal outcomes are often included in longitudinal models as long-term outcomes related to the change process. In LTA, distal outcomes can be included in a variety of ways. As depicted in Figure 2.10, distal outcomes can be related to the higher-order latent variable or related to the latent class variable at the last time point. Models that do not involve a mover-stayer variable often would have the distal outcome relate to class membership at the last time point (captured by the arrow between C_3 and the distal in Figure 2.10).

In Mplus, the impact on the distal outcome is assessed by allowing the mean of the distal outcome (or proportion if the distal is binary) to be independently estimated for each class of the variable it is related to. For example, to assess the relationship between latent class variable C_3 and the distal outcome, a different mean of the distal outcome is estimated for each class of C_3 . These distal outcome means can be compared to each other to determine if there is a significant difference across classes in terms of the distal outcome⁸.

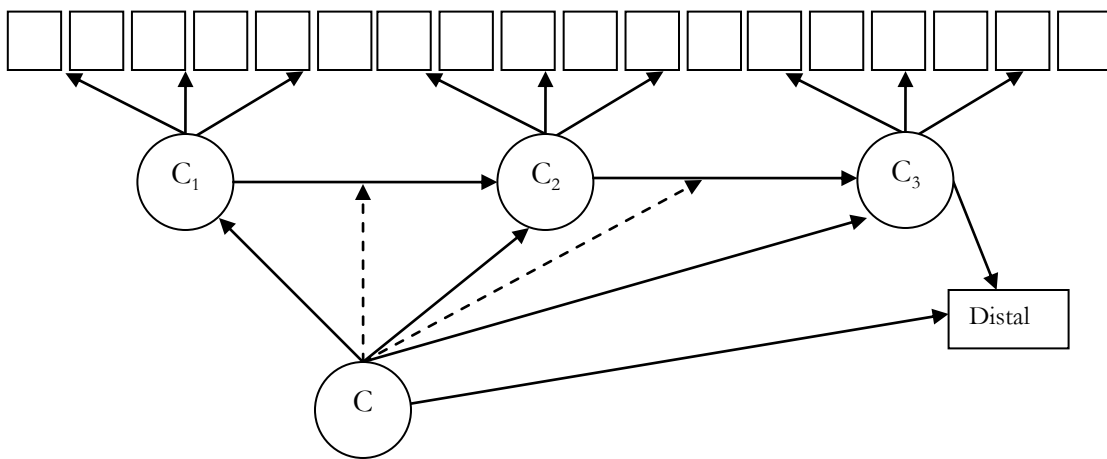

Figure 2.10. Model diagram of the LTA model with a higher-order latent class variable and a distal outcome.

Assessing Model Fit

There is not one commonly accepted way to assess overall model fit for LTA models. The frequency table chi-square statistics (either Pearson or likelihood ratio-based) is not recommended for the LTA model (McLachlan & Peel, 2000). This is because the chi-square distribution is not well approximated when there are large numbers of sparse cells, which often occurs with LTA models. For comparing nested LTA models that differ in how

⁸ To test if the distal outcome means are significantly different from each other, the “Model Test” feature in Mplus uses a Wald Test to test the difference of the two parameters. Another way to test distal outcome differences would be to fit two models (one allowing for different distal outcome means and another without) and then compare the fit of the models using an LRT.

change is specified (i.e., transition probabilities or measurement parameters), the traditional likelihood ratio (LRT) test can be used.

Another way to assess relative model fit is by using residuals. Specifically, the bivariate and response pattern standardized residuals can be used as a way to assess how well the model describes the observed data. The bivariate residuals are standardized Pearson residuals (Agresti, 2002; Haberman, 1973). The response pattern residuals are based on the difference between the observed and expected response pattern frequencies. A standardized residual that is larger than 1.96 in absolute value is considered a significant residual at the 5% level. For the bivariate residuals, the count of significant residuals for all possible bivariate relationships is used. When considering response patterns residuals, the number of significant residuals in the most frequent response patterns (e.g., the 10 most frequent response patterns) can be used to compare model fit. The model with a lower percentage of significant residuals would be considered the better fitting model⁹.

A careful and thoughtful application of the LTA model helps ensure the model is specified in an appropriate way. The analysis steps provided below are a way to help specify a LTA model that carefully takes into account the change process being modeled in a given dataset. The careful and systematic building of a LTA model helps researchers feel confident that the final model and its results are accurate and meaningful.

Analysis Steps

The following suggested analysis steps can be used in the application of an LTA model in real data analysis settings. The steps begin with descriptive statistics, building up to

⁹ Both types of residuals are provided by Mplus when “TECH10” is specified.

the specification of a longitudinal model that allows for the inclusion of a higher-order latent variable, covariates, and distal outcomes.

Step 0: Study Descriptive Statistics

As with any data analysis, the application of the LTA model begins by exploring the variables used in the analysis. This involves the detection of any possible suspicious missing data patterns, data input errors, and unexpected values that may be a result of a coding error or some other transcription problem. Summary tables are created for each variable used in the analysis (i.e., the outcome variables, covariates, and distal outcomes) and general trends noted. Summary information in the form of histograms or box plots for continuous variables can help detect outliers in addition to univariate descriptive statistics. Frequency tables for categorical outcomes can describe the distribution of the outcomes. All the descriptive explorations should be executed for each variable used at each time point in the analysis. Descriptive statistics can be compared within a given time point as well as across all time points to note general trends.

Step 1: Study Measurement Model Alternatives for Each Time Point

The use of multiple measures at each time point in the LTA model necessitates the selection of a measurement model that is independently explored at each time point. This involves fitting several possible measurement models for each time point and then collecting and comparing fit information on each model to determine which model is most appropriate for the given application. In the end, the appropriate measurement model will be selected based on the statistical model fit information, as well as on the interpretability and appropriateness for the larger longitudinal study. This step also includes exploring the

validity issues of the measurement model, aiming to ensure that the measurement model used provides useful and meaningful results in terms of understanding the outcome.

Covariates are included in the measurement model at each time point, and validity support is achieved when the covariates relate to the measurement model in meaningful ways based on the substantive theory of the outcome variables. This is a crucial step in the analysis since the measurement model is the foundation of the LTA model because it is used to capture the latent variable that is the outcome in the model.

Step 2: Explore Transitions Based on Cross-Sectional Results

After the measurement model has been selected, cross-sectional results can be used to describe change. Individuals can be assigned to their most likely latent class using modal class assignment. Cross-tabulations of class membership changes over time can be created as a proxy for changes that occur. These tables can be used to get a preliminary judgment of the type of movement occurring in the sample. Also, formal measurement invariance testing should take place in this step if the same number and type of classes emerged in the previous step.

Step 3: Explore Specification of the Latent Transition Model without Covariates

This step is the first one involving a formal longitudinal model. Depending on the number of observed items, classes, and measurement points, these models can take a long time to estimate. Therefore, to ensure that the specifications are correct, it is best to begin with just two or three measurement points. Then, once specification of the model becomes more familiar, the number of measurement points can be increased, eventually building up

to a model with all of the measurement points. This step includes the exploration of transition probability specifications, including stationarity and a higher-order effect.

Step 4: Include Covariates in the LTA Model

Once the LTA model has been specified, and invariance specifications and higher-order effects have been decided upon, covariates are included in the model. Observed covariates are included in this step and allowed to have either time-varying or time-invariant effects, depending on the application and research questions. Latent covariates, in the form of a higher-order latent class variable, can also be included if describing unobserved heterogeneity in development is of interest. A mover-stayer latent variable is an example of a higher-order latent covariate that can explore the stability of class membership over time.

Step 5: Include Distal Outcomes and Advanced Modeling Extensions

After exploring different ways to describe heterogeneity in development, a final model is selected. Because the model building strategy involves the specification of different models, this step integrates all the insight gained from each step along the way to specify a model using all of the information acquired. More advanced modeling extensions can also be included in this step, which may be related to the specific research questions of the study. This step includes distal outcomes and other variables in the model.

Summary

Taken together, the modeling ideas presented in this chapter highlight the flexibility in the specification of the LTA model that allows for a rich description of development. When LTA is considered within a more general latent variable modeling framework, a range of measurement models are available to ensure that the classes are captured in the optimal

way. Different model specifications allow for the testing of particular stage-sequential growth hypotheses and help ensure the statistical model directly relates to the developmental theory that motivates the analysis. This section further highlights the wide array of possible model specifications, including stationary assumptions on the transition probabilities, higher-order effects, and covariates and effects of distal outcomes. Each of these specifications requires attention, and they help ensure the specification of the model is based on a well-specified and developmentally informed final model. These suggested analysis steps can serve as a guide to the careful application of these modeling ideas. Chapter 3 includes the careful, systematic application of these steps to the peer victimization data.

Chapter 3. Methods and Results

This chapter discusses the application of Latent Transition Analysis (LTA) to the study of change in self-reported peer victimization using the analysis steps presented in Chapter 2. The application of the analysis steps includes a short discussion of the results of each step before moving onto the discussion of the next step. Because of this focus on model building, this chapter combines the Methods and the Results sections commonly seen in dissertations to enable a discussion of results in the context of each step. Doing this highlights how results from each step can be integrated into subsequent steps. This further allows for a discussion of some of the modeling decisions that often arise when statistical methods are applied to a dataset. Chapter 4 includes a synthesis of the analysis steps and discusses the results from the final model and how they contribute to our understanding of peer victimization.

This chapter presents intermediate modeling results as part of the model building process. These results, though regularly a part of any model-building process, are often not reported in published manuscripts that use LTA. This dissertation includes those results to show the different steps that researchers may encounter when working towards a final model. This model-building strategy is especially relevant in the application of a complex longitudinal model that involves both a measurement and a structural component, such as the LTA model.

The analysis steps presented in Chapter 2 are general enough to be applicable to a range of data-analysis applications. It is nearly impossible, however, to envision all the nuances that emerge in individual data-analysis settings. This chapter discusses the

relationship of the results of the analysis steps to the peer victimization data, and at times discusses steps that may not be applicable to other modeling settings. When appropriate, this chapter discusses how the analysis steps can be generalized to a broader context.

This chapter begins with the presentation of descriptive statistics for the variables used in the analysis for grades 6, 7, and 8. For the victimization outcomes, an exploration using a range of latent variable measurement models follows. After selection of an appropriate measurement model, cross-sectional results can be used to explore change. Issues of measurement invariance are also considered. Next, an LTA model without covariates is considered, and transition probability specifications and second-order effects are explored. Covariates that are both time-specific and time-varying are included in the LTA model. The application also includes latent covariates that help describe heterogeneity in development that is observed. The chapter ends with the specification of the final LTA model, a culmination of all the information gained in the analysis steps, which includes many advanced-modeling ideas. The Appendixes includes the Mplus syntax for all the models in this chapter.

A summary of the key analysis steps explored in each step in Chapter 2 is below:

Step 0: Study Descriptive Statistics

Step 1: Study Measurement Model Alternatives for Each Time Point

Step 2: Explore Transitions Based on Cross-Sectional Results

Step 3: Explore Specification of the Latent Transition Model without Covariates

Step 4: Include Covariates in the LTA Model

Step 5: Include Distal Outcomes and Advanced Modeling Extensions

Step 0: Study Descriptive Statistics

The first step in any data-analysis strategy is the use of descriptive techniques to explore the dataset. A variety of descriptive explorations are part of this step, including exploring missing data, checking to see if the distributional assumptions are met, and checking for any possible coding or other sort of error.

Starting with the six measured victimization items, Table 3.1 presents the observed sample sizes and the proportion endorsing each item by grade. Because these items are binary (i.e., 0/1), where 1 means that the item was endorsed, the endorsement proportions represent the item means.

Table 3.1. Observed sample size and proportion endorsed for the six binary peer victimization survey items for grades 6, 7, and 8

Variable	Grade 6		Grade 7		Grade 8	
	N	Prop.	N	Prop.	N	Prop.
Bad Names	1,931	0.37	1,707	0.25	1,565	0.20
Talked About	1,943	0.33	1,737	0.26	1,588	0.23
Picked On	1,936	0.28	1,722	0.19	1,582	0.14
Hit and Pushed	1,936	0.21	1,735	0.15	1,588	0.12
Things Taken/Messed Up	1,943	0.29	1,732	0.19	1,590	0.15
Laughed At	1,942	0.30	1,733	0.20	1,594	0.18

Several patterns are worth noting based on the results in Table 3.1. Within a given grade, the sample size variations are due to item non-response (i.e., a respondent does not respond to a given item), but the ranges of sample sizes for a given grade are in the same general range. Table 3.1 shows that the average sample size decreases from 1,938 in grade 6 to 1,727 in grade 7, and to 1,584 in grade 8. There is no evidence suggesting that one item had more missing data than the other items.

The item means describe the proportion of the sample that endorsed a given item. For example, 33% of the sample endorsed the “Talked About” victimization item in grade 6. Looking across the item endorsements for grade 6, it is notable that the item with the highest item endorsement was the verbal victimization item, “Called Bad Names,” which 37% of the sample endorsed. The lowest endorsement was the physical victimization item, “Hit and Pushed,” which only 21% endorsed. The item with the highest endorsement for both grades 7 and 8 was the “Talked About” item, with 26% and 23% endorsements, respectively. Within a grade, all six items had similar item endorsement rates. In other words, no one item had a significantly higher endorsement rate than the others. The overall item endorsement varied from grade to grade. The average item endorsement was 30%, 20%, and 17% for grades 6, 7, and 8, respectively. This decrease in the observed mean item endorsement was as expected because studies have shown that students experienced more peer victimization in grade 6 relative to grades 7 and 8.

Table 3.2 presents the means and standard deviations for the three time-varying covariates (depression, social anxiety, and school safety) and the two distal outcomes (social worries and physical symptoms) that are included in the analysis. The mean values of the time-varying covariates are not significantly different over time, although they do seem to be decreasing.

Table 3.2. Covariates summary for grades 6, 7, and 8 and high school distal outcomes

Measure	Grade 6	Grade 7	Grade 8	Grade 9
	<i>M (SD)</i>	<i>M (SD)</i>	<i>M (SD)</i>	<i>M (SD)</i>
Depression	0.25 (0.31)	0.24 (0.31)	0.24 (0.30)	**
Social Anxiety	2.18 (0.76)	1.99 (0.73)	1.84 (0.68)	**
School Safety	4.27 (0.60)	4.38 (0.61)	3.91 (0.38)	**
Social Worries	*	*	*	1.70 (0.51)
Physical Symptoms	*	*	*	1.69 (0.49)

* Variables not included as middle school covariates

** Variables not included as high school distal outcomes

Comments. This step used descriptive statistics to provide useful information about the observed data. Before moving to the next step, some important patterns are worth noting. First, within a grade, the item endorsements across the six items were in the same general range. This implies that no one item had a significantly higher endorsement than the others did—a result consistent across all three grades. The mean item endorsement for the victimization items decreased over time, which was expected given that victimization has been shown to be at its highest in grade 6 relative to the other grades in middle school. Nonetheless, even in grade 9, students continued to experience victimization. Further, there were no coding or input errors in the data, and there did not appear to be any indication that there were systematic missing data problems.

Step 1: Study Measurement Model Alternatives for Each Time Point

Step 1 involves the careful selection of a measurement model that accurately captures the construct of peer victimization used in this study. In this step, a series of measurement models are fit for each grade. The goal is to determine which model provides the best fit and

provides meaningful modeling results for each grade. Covariates and distal outcomes are included in the measurement model to help provide validity to the chosen model. An appropriate measurement model would be one that closely relates to the theoretical conceptualization of peer victimization and the results of the model should produce results that relate to other known covariates and outcomes in meaningful ways. That is, the selected measurement model should fit the data as well as be informative.

Chapter 2 introduced a series of latent variable models that one can use as a measurement model. The available models include ones with either continuous or categorical latent variables, as well as models that combine both types of variables. The models considered were: factor analysis (FA), latent class analysis (LCA), latent class factor analysis (LCFA), and factor mixture analysis (FMA). Each of the potential measurement models was fit independently to the data for each of the three grades of data (i.e., grades 6, 7, and 8).

Comparing Relative Fit of the Measurement Models

A variety of statistics can be used to assess model fit for latent variable models as described in Chapter 2. Eigenvalue plots are used to determine the number of factors in a factor analysis. For LCA models, the Bayesian Information Criterion (BIC), (Schwartz, 1978),¹⁰ and the Bootstrap Likelihood Ratio Test (BLRT) have been shown to be the best indicators of the number of classes (Nylund, et al., in press). For hybrid measurement models (i.e., LCFA and FMA), the BIC, the log likelihood (labeled “logL” in tables), and the number of parameters are used to compare the fit of nested or similar models.

When comparing measurement models, it is important to consider the practical implications of the model, not just statistical measures of fit. For example, it is important to

¹⁰ The fitted model that has the lowest BIC value is the model that provides the best relative fit.

consider how the model parameterizes the construct and if the model estimates describe important features about the correlation of the items with each other. Further, it is important that the model provide information in line with the substantive theory of the outcome. For example, if the solution of a factor analysis provides good fit but the factors are meaningless in terms of the understanding of victimization, it may not be a good measurement model.

It is important to note that mixture models, such as the LCA and hybrid models, are susceptible to converging on local, rather than global, solutions (McLachlan & Peel, 2000). The consideration of random start values is a way to help avoid this problem. The use of random starts is automatic when using Mplus, and the user can specify the number of random starts. A large enough set of random starts should be considered to ensure that the same likelihood value could be replicated. However, it is possible that even when a large number of random starts are specified (e.g., over 600), the models may not be able to converge on a stable solution. This could indicate that the model is not replicable. The number of random starts needed is important when deciding which measurement model to use.

It is also important to consider how the measurement model will be used in subsequent analyses. In longitudinal models, the measurement model defines the outcome used for the study of change. The measurement model is one of the most important parts of the longitudinal model. The outcome variable in the LTA model relates the observed variable to the larger longitudinal model. Thus, it is important to assess the stability of the measurement model over time and weigh the difficulties stemming from the complexity of the model against the increased amount of information the model provides about the outcome. The use of the hybrid latent variable models considered in this dissertation are not

commonly seen in the application of LTA in the literature, but are important because hybrid latent variable models may aid in more accurately describing a given construct.

Deciding on the Measurement Model

For each grade in the analysis, several measurement models were considered. For each type of model (i.e., LCA, LCFA, and FMA), the best fitting model was selected, and then the best fitting models across types were compared to determine which model should be the measurement model. It is possible that there is a not clear better fitting model for a given grade. When that occurred, it was noted and results from that grade were compared to the results from the other two grades to see if there was consistency across time points that could aid in the selection of the measurement model.

Grade 6 measurement model. Table 3.3 presents the model fit results for the grade 6 measurement models. Exploratory Factor Analysis (EFA) results indicated that a one-factor model fit the data based on eigenvalues and the interpretability of the solution (results not presented here). The factor analysis solution presented in Table 3.3 was based on a one-factor model estimated in a confirmatory factor analysis (CFA) framework so that the log likelihood and BIC values could be obtained for model comparison. Three LCA models that varied in the number of classes were estimated. The LCA models considered had 2-, 3-, and 4- classes. Based on the LCA results presented in Table 3.3, the lowest BIC value of the LCA models was for the 3-class model (BIC = 11,277.2). The nonsignificant p -value of the BLRT for the 4-class model indicated that the addition of one class to the 3-class model did not significantly improve model fit. Thus, the 3-class model was the best fitting of the LCA models considered (indicated by bolded text in Table 3.3)

Table 3.3. Factor analysis, latent class analysis, latent class factor analysis, and factor mixture analysis measurement model results for grade 6 (N = 1,900)

Model	Log L	BIC	No. of parameters	BLRT
FA, 1f	-5572.17	11234.92	12	*
LCA, 2c	-5618.92	1133.62	13	0.00
LCA, 3c	-5563.10	11277.26	20	0.00
LCA, 4c	-5548.45	11300.75	27	0.35
LCFA 1f, 2c	-5618.92	11336.20	13	*
LCFA 1f, 3c	-5572.20	11257.70	15	*
LCFA 1f, 4c	-5570.29	11268.91	17	*
FMA, 1f, 2c	-5553.33	11250.11	19	*
FMA, 1f, 3c	-5542.19	11280.71	26	*

Note. FA = Factor analysis, LCA = Latent class analysis, LCFA = Latent class factor analysis, and FMA = Factor mixture analysis. 1f = one factor, 1c = one class

*Indicates BLRT was not available for the model

The last two types of models considered were the hybrid latent variable models: the LCFA and the FMA. Three LCFA models were considered, one-factor models that had 2, 3, and 4 classes. Two FMA models were considered, models that had one factor but had two and three classes. Comparing the 3- and 4-class LCFA models that have somewhat close values on the fit indices, the two-point increase in the log likelihood value for the two parameters increase was not impressive, and the BIC was lower for the 3-class model. Together, this information indicates that the 3-class model was the best fitting model of the considered LCFA models.¹¹ Results for the two FMA measurement models are included in Table 3.3, which indicates that the model with one factor and 2 classes is superior¹². There is an 11-point decrease in the log likelihood value with the 7-parameter increase between 2-

¹¹ LCFA models that included more than one factor were explored; however, the likelihood value was not replicated in the random start exploration, even after a very large number of random starts were specified (i.e., 750 random starts). Further, the estimated model based on the best likelihood produced a solution with parameter estimates that were interpretable. These models were not included in the table.

¹² Though there are many FMA models that range in flexibility and specification, only one FMA model is considered in this exploration.

and 3-class FMA models. However, the BIC indicates that the FMA model with 2-classes fits better. Thus, of the hybrid models, the 3-class LCFA and the 2-class, 1-factor FMA are the best fitting models of their respective types.

Having decided on the best model within each type of model considered, the next step was to decide on the best measurement model for grade 6 by comparing across model types. Considering models identified as best fitting for each type, similar model fit comparisons were made. The models that were compared were the 1-factor model, the 3-class LCA model, the 3-class LCFA, and the 2-class FMA.¹³ The highest value of log likelihood was for the 1-factor, 2-class FMA and the lowest value of BIC was for the 1-factor FA model. The most natural comparison model to the 1-factor FA is the LCA model. While the log likelihood value for the 3-class LCA is close in value to the 1-factor FA, the BIC indicates that the FA model is preferred because the LCA model estimates more parameters. Neither the FA nor the 3-class LCA models have any significant bivariate or response pattern residuals (obtained using Tech10 in Mplus) and provide about the same relative fit.

The next best fitting model was the 1-factor, 2-class FMA model. The results of this model used a large number of start values and the solution was not easily interpretable. Specifically, the factor loadings were nonsensical where all items had positive loading and one had a negative loading. This was a result not seen in the one-factor FA. Thus, even though the FMA model fit indices indicated it was the best fitting of the hybrid models, there were concerns about the stability and interpretability of the results.

¹³ When comparing fit of a several models, a model that is thought to be relatively well-fitting model is one that has a high log likelihood value (i.e., closer to zero) and a low BIC value, relative to the values of the other models.

In sum, a series of measurement models were explored for grade 6. The best fitting model for each type was identified, and then the types were compared. The BIC indicated that the 1-factor FA model fit the best followed by the FMA model. The results of the FMA were not interpretable and the results may not be stable. Comparing the 1-factor FA and the 3-class LCA model in terms of the number of standardized residuals, there was not a significant difference in these models. As a result of this and close values on the other fit indices, the 3-class LCA model was preferred over the FA model since it provided classifications that can be used to study transitions in victimization.

Grades 7 and 8 measurement models. The process used to identify an appropriate measurement model was described in detail for grade 6, but because similar decisions were made for grades 7 and 8 the discussion is abbreviated. The same set of possible measurement models were fit for each grade, and model fit information is included in Tables 3.4 and 3.5, for grades 7 and 8, respectively.

Table 3.4. Factor analysis, latent class analysis, latent class factor analysis, and factor mixture analysis measurement model results for grade 7 (N = 1,714)

Model	LogL	BIC	No. of parameters	BLRT
FA, 1f	-4227.28	8543.92	12	*
LCA, 2c	-4253.51	8603.82	13	0.00
LCA, 3c	-4221.84	8592.62	20	0.02
LCA, 4c	-4209.33	8619.71	27	0.19
LCFA, 2c, 1f	-4253.51	8603.82	13	*
LCFA, 3c, 1f	-4227.90	8567.49	15	*
LCFA, 4c, 1f	**	**	**	**
FMA, 1f, 2c	-4211.45	8564.39	19	*
FMA, 1f, 3c	-4197.50	8588.62	26	*

Note. FA = Factor analysis, LCA = Latent class analysis, LCFA = Latent class factor analysis, and FMA = Factor mixture analysis. 1f = one factor, 1c = one class

*Indicates the BLRT was not available for the model

**Model results not obtained because the model did not converge

Considering the best-fitting models for each type of model, the results for grade 7 were similar to those observed for grade 6. The 1-factor FA and the FMA models seem slightly superior to the LCA models. The slight improvement in the log likelihood of the FMA model compared to the LCA model indicates there is likely no need for the within-class variation that the FMA allows. As with grade 6, a large number of random starts were needed for both FMA models to converge, but the log likelihood values were not replicated for either model. Comparing the fit of the FA and LCA models as done for grade 6, there was no difference in the number of significant standardized bivariate residuals, and only a slight difference in terms of the response pattern residuals. Specifically, the FA model had 2 significant response pattern residuals while the LCA only had one. As a result of these models being similar in terms of fit, the 3-class LCA model was deemed the most reasonable

for grade 7, since it classifies students into latent classes that provide a clear way to study transitions.

Table 3.5. Factor analysis, latent class analysis, latent class factor analysis, and factor mixture modeling measurement model results for grade 8 (N = 1,564)

Model	LogL	BIC	No. of parameters	BLRT
FA, 1f	-3315.87	6720.00	12	*
LCA, 2c	-3366.94	6829.50	13	0
LCA, 3c	-3314.93	6776.96	20	0.02
LCA, 4c	-3300.95	6800.48	27	0.22
LCFA, 2c, 1f	-3366.94	6829.51	13	*
LCFA, 3c, 1f	-3316.59	6743.51	15	*
LCFA, 4c, 1f	**	**	**	**
FMA, 1f, 2c	-3291.36	6722.47	19	*
FMA, 1f, 3c	-3298.18	6787.59	26	*

Note. FA = Factor Analysis, LCA = Latent Class Analysis, LCFA = Latent Class Factor Analysis, and FMA = Factor Mixture Models; 1f = one factor, 1c = one class

*Indicates BLRT was not available for the model

**Model results not obtained because the model did not converge

Results for the measurement models considered for grade 8 are presented in Table 3.5. As with the results from the grade 7, the hybrid models provided a better fit to the data based on the log likelihood values, but the results required many random starts to converge on a stable solution. The FMA model again used many random starts and the likelihood value was not replicated. Similar to the other grades, the two most compelling measurement models for grade 8 were the 1-factor FA model and the 3-class LCA model. Comparing the FA and the LCA models, there were no significant standardized or response pattern residuals for either model. Thus, the 3-class LCA model was deemed the most reasonable among the models considered because it provides classification for studying transitions. The

3-class LCA model solution for grade 8 was similar to 3-class LCA solutions for the other grades.

Deciding on the appropriate measurement model. As noted, when deciding on a measurement model in longitudinal data analysis, things to consider involve not only the statistical indicators of how well the model fits the data, but also the interpretability of the results and how the solution will be used in subsequent models. While the FMA and LCFA models provided better fit in terms of the statistical indices, the instability in these models over time called into question how replicable the solutions were and how necessary the hybrid models were in terms of capturing important aspects of the construct for this particular dataset. Again, when comparing the LCA and LCFA models, there was little improvement in fit, indicating that the within-class variance provided by the factor in LCFA is not needed.

The 1-factor FA model and the 3-class LCA model provided relatively similar fit in terms of the statistical indices and neither resulted in any significant bivariate residuals. If the FA model were used, it would provide a continuum of victimization while the LCA solution provides classification into distinct classes (i.e., groups). Previous studies of victimization identify groups of students based on victimization and compare student experiences across the groups. The LCA solution provides a way to classify students based on their victimization experiences, but instead uses a model based way to create the groups. Further, the emergence of the three latent classes over time provides a way study victimization experiences over time using transition analysis. In this application, a factor analysis model provides a comparable model fit to the LCA model and could provide a meaningful way to

describe victimization if the goal was to describe a continuum of victimization. The LCA solution is the one preferred for the current application.

In other applications, the LCA model may not have been chosen as the measurement model. The results will vary based on the dataset, the type, and the number of items used, and the construct being studied. In another application, the hybrid models could provide better fit and reasonable solutions relative to the other models considered. Further, it is possible to use different measurement models over time, an LTA modeling extension not commonly seen in the literature. Further, even if LCA is used at each time point, it is not necessary that the same number of classes may emerge over time. These models are possible extensions of the model, though not commonly explored.

Exploring the 3-class LCA Solution

Having decided on a reasonable measurement model across all grades, the next step is to see if the results can be validated using other criteria. Concurrent and predictive validity are explored using variables with theoretically supported relationships with peer victimization. Relationships with the latent classes that reflect substantive theory about peer victimization help to provide validity to the latent classes. Before validity is explored, it is important to interpret the LCA solutions and ensure that the classes are meaningful.

Interpreting the classes. For LCA models, conditional item probabilities are used to attach substantive meaning to the latent classes. These values are the probability of endorsing an item for individuals within a given class. Much like using factor loadings to attach a name to factors in factor analysis, the conditional item probabilities can be used to attach a label to the classes. Conditional item probabilities are displayed graphically using item-probability plots.

Figure 3.1 displays item-probability plots for the 3-class solution for grades 6, 7, and 8. Along the x-axis of each plot are the six peer victimization items. The y-axis represents the probability of endorsing a given item. The top plot of Figure 3.1 presented the grade 6 results. The three lines, called profiles, correspond to the three classes in the LCA solution and the values are the conditional item probability for each of the six items across the three classes. Looking at the grade 6 plot, the top profile (plotted with diamonds), which represents 19% of the sample, indicates that the individuals in this class had a high probability of endorsing all the victimization items—not just one or two of the items. Thus, this class is the “victimized” class. The middle line (plotted with squared), which represented 29% of the sample, indicates a moderate probability of endorsing the victimization items. This class is the “sometimes-victimized” class. The bottom line (plotted with triangles), which represented 52% of the sample, indicates a low probability of endorsing the six victimization items and is the “nonvictimized” class.

Grade 6 (N = 1,900)

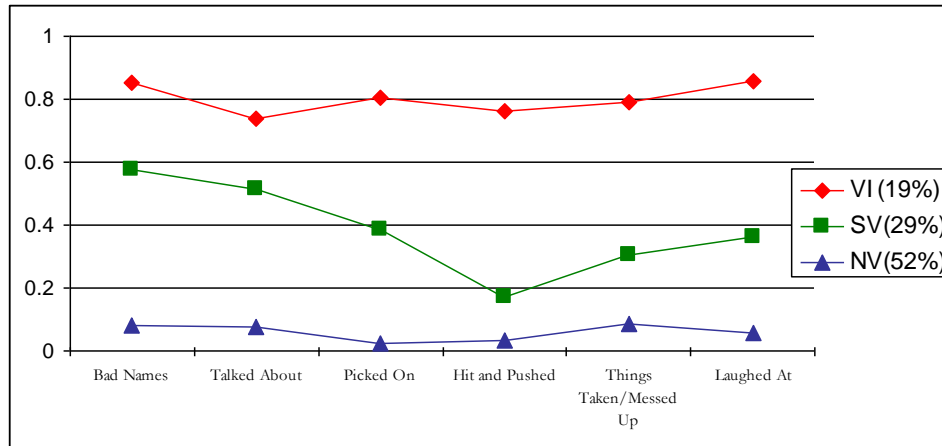

Grade 7 (N = 1,714)

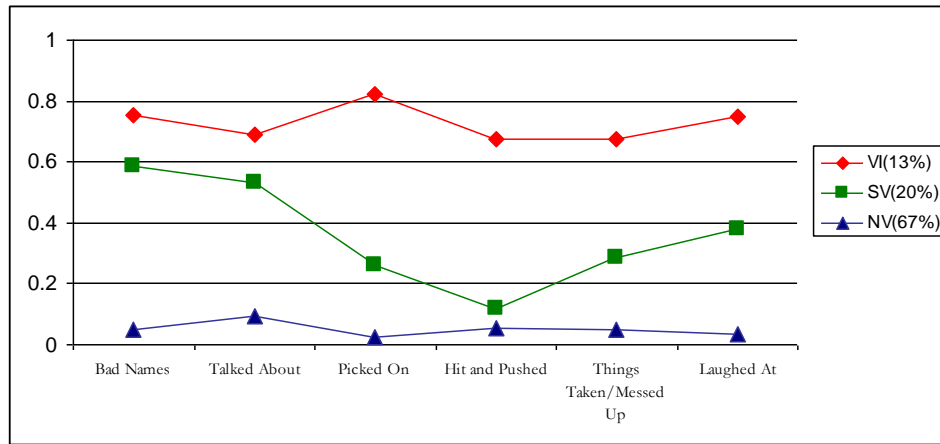

Grade 8 (N = 1,564)

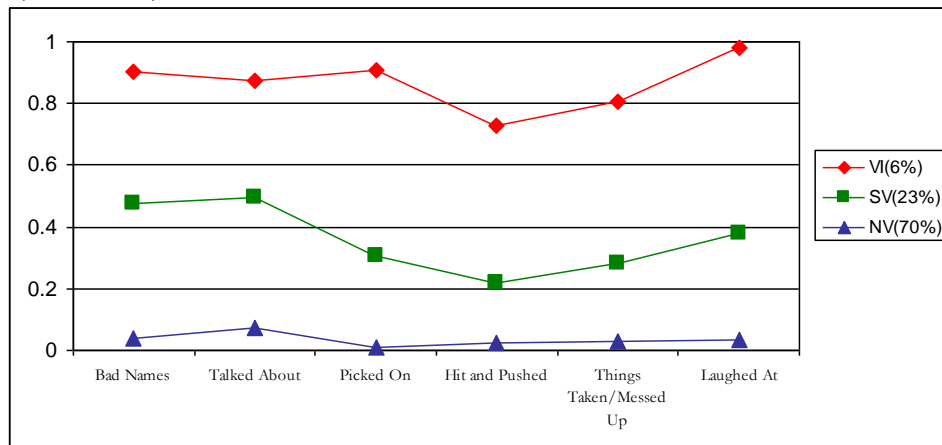

Figure 3.1. Conditional item probability plots for the 3-class LCA by grades 6, 7, and 8. Class size information is in the legend. *Note:* VI class = victimized class, SV class = sometimes-victimized class, NV class = nonvictimized class.

When looking across grades 6, 7 and 8, one sees similar profiles. Specifically, two extreme classes consistently emerged: a victimized class with a high probability of endorsing all of the items and a nonvictimized class that had a low probability of endorsing all of the victimization items. While the shape of the sometimes-victimized class changed a little over time, it remained clearly distinct from the other two. Thus, while the shape varies slightly in terms of the mean endorsement of two or three of the items, the sometimes-victimized class was a meaningful class that remained relatively consistent over time compared to the other victimization classes.

Table 3.6 presents the conditional item probability values for the three victimization classes for grades 6, 7, and 8. These values represent the mean probability of endorsement for the students in a given class and are used to create the item probability plots in Figure 3.1. As noted before, there were similar patterns across the three grades, so general trends can be noted without discussing a specific grade. The conditional item probabilities for the victimized class (first column in Table 3.6) ranged between 0.98 and 0.75. The individuals in the sometimes-victimized class, represented by the middle column in Table 3.6, had item probabilities ranging from 0.57 to 0.11. The individuals in the nonvictimized class, represented by the far right column, had low conditional item probabilities that ranged between 0.09 and 0.02.

Table 3.6. Conditional item probabilities for the 3-class LCA solution by grades 6, 7, and 8

		Victimization Classes		
	Victimization Item	Victimized	Sometimes-victimized	Non-victimized
Grade 6 N=1,900	Bad Names	0.85	0.58	0.08
	Talked About	0.74	0.51	0.07
	Picked On	0.81	0.39	0.03
	Hit and Pushed	0.76	0.17	0.03
	Things Taken/Messed Up	0.79	0.31	0.09
	Laughed At	0.86	0.36	0.06
		Victimized	Sometimes-victimized	Non-victimized
Grade 7 N=1,714	Bad Names	0.76	0.59	0.05
	Talked About	0.69	0.53	0.09
	Picked On	0.82	0.26	0.03
	Hit and Pushed	0.68	0.12	0.05
	Things Taken/Messed Up	0.68	0.29	0.05
	Laughed At	0.75	0.38	0.03
		Victimized	Sometimes-victimized	Non-victimized
Grade 8 N=1,564	Bad Names	0.90	0.48	0.04
	Talked About	0.88	0.50	0.08
	Picked On	0.91	0.31	0.01
	Hit and Pushed	0.73	0.22	0.02
	Things Taken/Messed Up	0.81	0.28	0.03
	Laughed At	0.98	0.38	0.04

Investigating item patterns. Another way to understand the classes that emerge from LCA is to look at the observed response pattern of an individual in each of the victimization classes. This is achieved by using posterior probabilities to assign each individual to one of the victimization classes and then exploring the response patterns for those classified in each of the three classes. Table 3.7 includes summary tables for each class across grades 6, 7, and

8. These tables display information about the profiles that comprise each of the victimization classes. For each profile, the observed response patterns for each class is displayed (1 = endorsed the item)¹⁴ and is the probability of individuals who exhibited a given pattern to be in each of the three victimization classes (i.e., $P(VI)$ = probability of individuals with the given profile to be in the victimized class). Also included is the frequency of each of the patterns and the total number of items endorsed by each pattern (i.e., a sum of items with a “1” for each pattern).

¹⁴ For the sake of clarity in the tables, grade 6 profiles with frequencies over 15 are included in the table. For grades 7 and 8, profiles with frequencies over 10 are included in the tables.

**Table 3.7. Item response patterns for each victim class, presented by grade
Grade 6**

	Bad Names	Talked About	Picked On	Hit and Pushed	Things Taken/Messed	Laughed At	P(VI)	P(SV)	P(NV)	Freq	# Items Endorsed
VI	1	1	1	1	1	1	0.98	0.02	0.00	96	6
	1	1	1	1	0	1	0.93	0.07	0.00	31	5
	1	1	1	0	1	1	0.78	0.22	0.00	25	5
	1	1	0	1	0	1	0.77	0.23	0.00	22	4
	1	0	1	1	1	1	0.93	0.07	0.00	22	5
	1	1	0	1	1	1	0.93	0.07	0.00	22	5
	1	1	1	1	1	0	0.79	0.21	0.00	16	5
	0	1	1	1	1	1	0.90	0.10	0.00	13	5
	1	0	0	1	1	1	0.76	0.24	0.00	12	4
SV	1	1	0	0	0	0	0.01	0.86	0.13	43	2
	0	0	1	0	0	0	0.00	0.67	0.33	32	1
	1	0	1	0	0	0	0.01	0.95	0.04	28	2
	0	0	1	0	1	0	0.01	0.93	0.06	25	2
	0	1	0	0	1	0	0.01	0.79	0.20	25	2
	1	1	1	0	0	0	0.05	0.94	0.00	25	3
	1	1	1	0	0	1	0.46	0.54	0.00	22	4
	1	1	0	0	0	1	0.17	0.82	0.01	20	3
	1	0	1	0	1	1	0.45	0.55	0.00	19	4
	1	0	0	0	1	0	0.01	0.82	0.17	18	2
	1	0	0	0	0	1	0.04	0.82	0.14	17	2
	1	0	0	0	1	1	0.16	0.82	0.02	17	3
	1	1	0	0	1	1	0.47	0.53	0.00	17	4
	0	1	1	0	0	0	0.01	0.95	0.05	15	2
1	1	0	0	1	0	0.05	0.93	0.02	15	3	
NV	0	0	0	0	0	0	0.00	0.05	0.95	688	0
	1	0	0	0	0	0	0.00	0.39	0.61	86	1
	0	1	0	0	0	0	0.00	0.34	0.66	75	1
	0	0	0	0	1	0	0.00	0.27	0.73	67	1
	0	0	0	0	0	1	0.00	0.31	0.69	55	1
	0	0	0	1	0	0	0.00	0.30	0.70	25	1

**Table 3.7 (cont.). Item response patterns for each victim class, presented by grade
Grade 7**

	Bad Names	Talked About	Picked On	Hit and Pushed	Things Taken/Messed	Laughed At	P(VI)	P(SV)	P(NV)	Freq	# Items Endorsed
VI	1	1	1	1	1	1	0.98	0.02	0.00	39	6
	1	1	1	0	0	1	0.63	0.37	0.00	23	4
	1	1	1	0	1	1	0.88	0.12	0.00	18	5
	1	1	1	1	0	1	0.94	0.07	0.00	12	5
	1	0	1	1	1	1	0.93	0.07	0.00	12	5
SV	1	1	0	0	0	0	0.02	0.86	0.12	40	2
	0	0	1	0	0	0	0.01	0.64	0.35	26	1
	0	1	0	0	0	1	0.03	0.83	0.14	19	2
	1	0	1	0	0	0	0.04	0.94	0.03	16	2
	0	0	1	0	1	0	0.03	0.93	0.04	16	2
	1	1	0	0	1	1	0.47	0.53	0.00	16	4
	1	0	0	0	1	0	0.02	0.91	0.07	15	2
	1	1	0	0	0	1	0.17	0.82	0.01	15	3
	0	0	0	0	1	1	0.03	0.89	0.08	14	2
	1	0	0	0	0	1	0.04	0.90	0.05	13	2
	0	1	1	0	0	1	0.23	0.77	0.00	12	3
	1	1	0	0	1	0	0.09	0.90	0.01	11	3
	0	0	1	1	0	0	0.06	0.85	0.09	10	2
	1	1	1	0	0	0	0.16	0.84	0.00	10	3
1	1	1	0	1	0	0.45	0.55	0.00	10	4	
VI	0	0	0	0	0	0	0.00	0.04	0.96	830	0
	0	1	0	0	0	0	0.00	0.25	0.75	101	1
	1	0	0	0	0	0	0.00	0.48	0.52	63	1
	0	0	0	0	1	0	0.00	0.37	0.63	48	1
	0	0	0	1	0	0	0.00	0.18	0.82	41	1
	0	0	0	0	0	1	0.00	0.45	0.55	38	1
	*	0	0	0	0	0	0.00	0.08	0.92	11	0

**Table 3.7 (cont.). Item response patterns for each victim class, presented by grade
Grade 8**

	Bad Names	Talked About	Picked On	Hit and Pushed	Things Taken/Messed	Laughed At	P(VI)	P(SV)	P(NV)	Freq	# Items Endorsed
VI	1	1	1	1	1	1	0.99	0.02	0.00	42	6
	1	1	1	0	1	1	0.87	0.13	0.00	14	5
	1	1	1	1	0	1	0.86	0.14	0.00	11	5
SV	1	1	0	0	0	0	0.00	0.88	0.12	29	2
	1	0	0	0	0	1	0.00	0.90	0.10	20	2
	0	0	1	0	0	0	0.00	0.57	0.43	18	1
	0	1	0	0	0	1	0.00	0.84	0.16	14	2
	1	1	0	0	0	1	0.03	0.96	0.01	14	3
	0	1	0	0	1	0	0.00	0.80	0.20	12	2
	1	1	1	0	0	0	0.01	0.99	0.00	12	3
	1	1	1	0	0	1	0.39	0.61	0.00	11	4
NV	0	0	0	0	0	0	0.00	0.03	0.98	883	0
	0	1	0	0	0	0	0.00	0.24	0.76	88	1
	1	0	0	0	0	0	0.00	0.37	0.63	52	1
	0	0	0	0	0	1	0.00	0.30	0.70	44	1
	0	0	0	0	1	0	0.00	0.25	0.75	34	1
	0	0	0	1	0	0	0.00	0.25	0.75	24	1
	*	0	0	0	0	0	0.00	0.05	0.95	15	0

The item response patterns presented in Table 3.7 show notable patterns. Students classified in the victimized class were likely to endorse either all six victimization items or at least 5 of the 6 items. If a student in the victimized class did not endorse all six of the items, that student was most likely not to have endorsed the “hit and pushed” or “things taken/messed up” items. Students in the nonvictimized class mostly endorsed either none or just one of the six victimization items. If a student in the nonvictimized class endorsed an item, that student was most likely to endorse the “bad names” or “talked about” items.

Students in the sometimes-victimized class were likely to endorse between two and four of the six victimization items. If students in this class endorsed two or three items, the items most likely to be endorsed were the “bad names,” “talked about,” or “picked on” items. The profiles observed in the sometimes-victimized class support the fact that there is no one clear pattern of endorsement for this class and that the class identifies students who endorse some of the victimization items.

Victimization class size changes. While the three item profile plots in Figure 3.1 remained remarkably consistent across time, the size of the victimization classes did change. Table 3.8 presents the class proportions of the three victimization classes for grades 6, 7, and 8.

Table 3.8. Percent of students in each victimization class in grades 6 through 8 based on cross-sectional LCA without covariates

Classes	Grade 6	Grade 7	Grade 8
Victimized	19%	13%	6%
Sometimes-Victimized	29%	20%	23%
Nonvictimized	52%	67%	70%

Comparing the class sizes presented in Table 3.8, there are a few things to note. First, the relative class ordering by size remains the same. That is, the victimized class was consistently the smallest, the sometimes-victimized class was the next smallest, and the nonvictimized class was always the largest and the majority. In addition, the size of the victimization class decreased from 19% in grade 6 to 6% in grade 8, which indicated that the victimized class decreases in size as students move up the grades. At the same time, the nonvictimized class increased from 52% in grade 6 to 70% in grade 8. Thus, based on the

sizes of the classes presented in Table 3.8, it could be hypothesized that in middle school students moved from the victimized class to the nonvictimized class as they moved from grade 6 to grade 8. While these results were based only on the cross-sectional analysis, they can be used to describe the type of movement among the three victimization classes over time.

Covariates in the measurement model. Although the selection of the measurement model was considered without covariates, the inclusion of covariates in the LCA model was used to validate the classes that emerged. Covariates were included, and results indicate meaningful relationships in the direction and significance that, as expected, loaned support to the validity of the classes. If, for example, a covariate was included and the direction and significance of the covariate's influence was contradictory or nonsensical to theories about how the covariate and outcomes related, this could indicate that the model used was not correct, or that the classes that emerged were not meaningful. Figure 3.2 displays the LCA regression model diagram, including the covariates of gender and students' self-reports of school safety. The figure also displays the proximal distal outcome used as further validation, which in this application is the variable measuring student's depressive feeling in the fall of the following academic year.

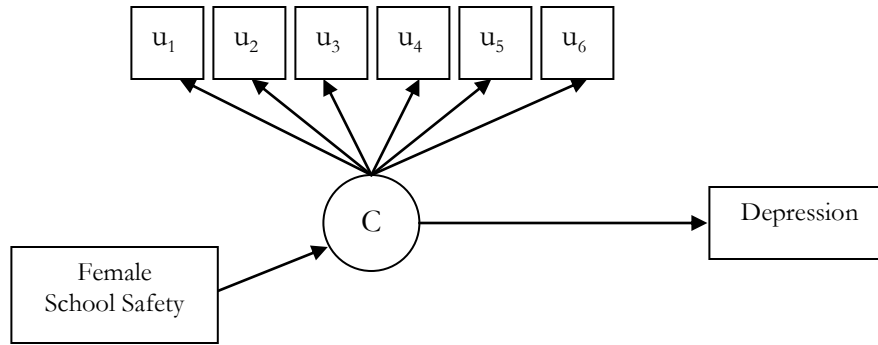

Figure 3.2. Latent class regression model diagram with covariates (female and school safety) and distal outcome (depressive feeling for the fall of the following school year).

LCA regression models for each grade were analyzed independently. There are several ways to specify LCA models that include covariates, which vary in the way the covariates influence the formation of the classes. In this study, we are interested in validating the victimization classes that emerged based on analysis using only the six peer victimization items. Thus, the LCA models with covariates had fixed class-specific item probabilities, where the item probabilities values were fixed at values from the 3-class LCA model without covariates. This was done to ensure that the covariate values and distal outcome means were estimated based on the three victimization classes described earlier. This method of fixing the item probabilities is not used in the subsequent longitudinal analysis.

Results indicated that covariate and distal outcome relationships emerged as expected for the three victimization classes. Table 3.9 includes the logistic regression coefficients, standard errors, χ^2 - score, p - value and odds ratio values for the independent analysis of the three grades in this study, where the nonvictimized class is the reference group. Thus, two covariate comparisons were made: (1) the likelihood of being the

victimized class compared to the nonvictimized class and (2) the likelihood of being the sometimes-victimized class compared to the nonvictimized class.

Results indicated that in grade 6, male and female students were equally likely to be in the three victimized classes (i.e., the regression coefficients were not significant). However, for grades 7 and 8, there was a significant gender effect when comparing the nonvictimized to the victimized class. The gender logistic regression coefficient for grade 7 (-0.542, $p < .05$) indicated that being male instead of female increased the odds of being in the victimized class relative to the nonvictimized class. The odds ratio, calculated by taking the exponential of the logistic regression coefficient, can be used as another way to describe this result ($OR = 0.58$). The significant gender effect comparing the odds of being in the victimized and nonvictimized classes was consistent for both grades 7 and 8. However, there was not a significant gender coefficient comparing the sometimes-victimized class to the nonvictimized class. This result indicated that male and female students were equally likely to be in the sometimes and nonvictimized classes across all grades. The fact that there was no gender difference in grade 6 when comparing the victimized to the nonvictimized classes, but that male students were more likely to be in the victimized class in grades 7 and 8, may be an indication that students who transitioned out of the victimized class were mostly female.

Table 3.9. Logistic regression coefficients and odds ratio for 3-class model with school safety and gender (males = 0, females = 1) as a covariate using the nonvictimized class as the comparison group

		<i>Effect</i>	<i>Coefficient</i>	<i>S.E.</i>	<i>Z</i>	<i>P-value</i>	<i>Odds Ratio</i>
Grade 6							
Victimized	Female		-0.37	0.21	-1.73	0.08	0.69
	Safety		-2.18	0.19	-11.78	0.00	0.11
Sometimes-victimized							
Sometimes-victimized	Female		0.00	0.16	0.01	0.99	1.00
	Safety		-1.42	0.18	-8.14	0.00	0.24
Grade 7							
Victimized	Female		-0.54	0.14	-3.86	0.00	0.58
	Safety		-2.10	0.21	-10.09	0.00	0.12
Sometimes-victimized							
Sometimes-victimized	Female		0.20	0.18	1.09	0.28	1.22
	Safety		-1.22	0.20	-6.12	0.00	0.29
Grade 8							
Victimized	Female		-0.41	0.12	-3.50	0.00	0.67
	Safety		-1.10	0.25	-4.48	0.00	0.33
Sometimes-victimized							
Sometimes-victimized	Female		-0.04	0.28	-0.14	0.89	0.96
	Safety		-1.67	0.23	-7.21	0.00	0.19

School safety had a similar influence among the three victimization classes when compared across all three grades. Specifically, there were significant school safety effects for both the victimized and sometimes-victimized classes compared to the nonvictimized class. The school safety logistic regression coefficient for grade 6 (-2.175, $p < .001$) indicated that students with higher feelings of school safety had lower odds of being in the victimized class instead of the nonvictimized class. Similarly, the logistic regression coefficient (-1.422, $p < 0.001$) for the sometimes-victimized class compared to the nonvictimized class indicates that students with higher feelings of school safety had lower odds of being in the sometimes-victimized class instead of the victimized class. This indicated that students in the

nonvictimized class were more likely to feel safer at school. Table 3.9 shows this pattern remained consistent across all middle school grades.

Students' depressive feelings (i.e., depression) were included as a proximal distal outcome in the LCA model. The impact of a distal outcome was included by allowing the means of the students' depression score to vary across the three victimization classes. Since the data come from a larger longitudinal study, students' depressive symptoms that were measured in the subsequent academic semester (i.e., fall of the next year) were available. This allowed for the exploration of mean differences in depressive feelings across the victimization classes.

Table 3.10. Mean depressive feelings for the three victimization classes

Class	Fall of Grade 7	Fall of Grade 8
Victimized	0.40	0.41
Sometimes-victimized	0.26	0.31
Nonvictimized	0.17	0.16

Note. Class membership was determined with gender and school safety as covariates one wave prior to the measurement of depressive feelings.

The results in Table 3.10 indicate that, in fact, students in the victimization class did have higher depression means in the following semester than those in the less frequently victimized classes. The estimated depression means followed an expected pattern, where students in the victimized class reported the highest level of depressive feelings, the students in the sometimes-victimized class reported the next highest level of depressive feelings, and the students in the nonvictimized class reported the lowest level of depressive feelings.

Exploring differential item functioning. Before settling on the 3-class LCA model and moving onto the next phase of the analysis, the last step is to check for differential item functioning (DIF). DIF in the LCA setting implies that two students in the same

victimization class would have differential item endorsement probabilities. For example, in the context of peer victimization, DIF could result from female students in the victimized class having higher probability of endorsing the “talks about” item than male students. DIF in LCA is explored by allowing a direct effect of the covariate onto an item. The most reasonable source of DIF for this study would be gender. Figure 3.3 displays an LCA model with a direct effect of gender on an item.

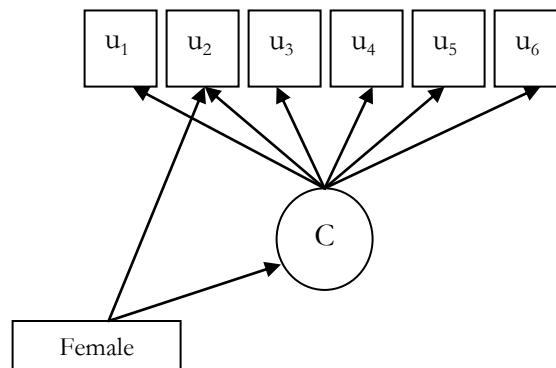

Figure 3.3. LCA model with gender as a covariate that has a direct effect on item (u_2) and on the latent class variable used to explore differential item functioning.

A series of models were fit to explore the possibility of DIF in this example. Specifically, at each time point DIF was explored for two items, the “talks about” and “hits and pushed” items. For each of these items, inconsistent results emerged. For the “talks about” items, there was evidence of DIF in grades 6 and 8, but not 7. This indicated that in the sometimes-victimized class, females were more likely to have endorsed the “talks about” item than boys. This was not consistent across all grades, however. Results for the “hit and pushed” victimization item were also inconsistent across grades. The main findings were that boys in the sometimes-victimized and victimized classes were more likely to endorse the

item than girls in grade 6, but in grades 7 and 8 boys in the sometimes-victimized class were more likely to endorse it than girls in that class.

There was evidence of DIF in these two victimization items, though their effect was inconsistent across grades. If there were a consistent signal of DIF for a given item across time, it would be important to incorporate it in the longitudinal model. In this setting, given the inconsistency of the effect, DIF was not incorporated in the LTA model in subsequent steps. It is worthwhile to explore the effect of ignoring DIF in these models.

Comments. Step 1 is a very important stage in building the longitudinal model. The accurate selection of a measurement model is integral in modeling change in a construct. Several latent variable models were considered as potential measurement models for the six peer victimization items. Considering a number of statistical fit indices and practical implications, the LCA model was identified as the most practical solution for this given dataset. Two covariates and a distal outcome variable were included in the cross-sectional LCA models to explore validity of the three victimization classes that emerged. Across all three grades, the 3-class LCA model was identified as the most practical and understandable selection for the measurement model. Remarkably, the three classes were very similar in structure. The three classes that emerged differed in their probability of endorsing all six peer victimization items, thus differentiating victimization experiences based on degree rather than type.

Relationships with covariates and distal outcomes that emerged were congruent with what would be expected of victimization classes of this sort. Taken together, these results provide support for the validity of the classes as meaningful classes that describe students' victimization experiences. Last, the possibility of DIF was explored at each time point for

two of the items. There was evidence of DIF for the items, but because of inconsistent results across time, the DIF will not be included in the next analysis steps. Since LCA is the selected measurement model, the longitudinal model will describe the changes students make in their victimization classes over time.

Step 2: Explore Transitions Based on Cross-Sectional Results

After the selection and validation of the measurement model, the next modeling step involves using cross-sectional results to describe change that occurs among the latent classes. Using modal class assignment based on the LCA posterior probabilities, individuals were assigned to one of the three classes. This was done for grades 6, 7, and 8, and class membership information was merged across grades to create cross-classification tables. These tables were used to describe individual movement among the victimization classes over time. Table 3.11 includes the cross tabulations for the two transition points (i.e., grade 6 to 7 and grade 7 to 8).

Table 3.11. Preliminary transition tables based on cross-sectional LCA results

		Grade 7			Grade 8			
Grade 6		VI	SV	NV	Grade 7	VI	SV	NV
VI		0.46	0.31	0.24	VI	0.19	0.43	0.38
SV		0.18	0.34	0.48	SV	0.05	0.22	0.74
NV		0.06	0.24	0.70	NV	0.02	0.11	0.87

Note: VI class = victimized class, SV class = sometimes-victimized class, NV class = nonvictimized class

The transition matrices presented in Table 3.11 are very similar to the transition matrices estimated by the LTA model. Transition tables based on an LTA model use model estimates to create transition tables; the values in the table above are descriptive statistics.

These tables are useful for summarizing individual movement in and out of the victimization classes that may be observed when estimating the transitions using the longitudinal model.

Several important patterns emerged from the cross-classification matrices presented in Table 3.11. Along the diagonal axis are values that describe stability in victimization status. The diagonal values include students who remained in the same modally assigned victimization group at adjacent time points. Looking at the first upper left cell of the first matrix of Table 3.11, the value of 0.46 can be interpreted as follows: The probability that an individual who was in the victimized class in grade 6 remained in the victimized class in grade 7 is 0.46. Alternatively, that value can be interpreted as follows: 46% of the students who were in the victimized class in grade 6 remained in the victimized class in grade 7.

The off-diagonal values described movement among the classes. The value of 0.31 in the first matrix of Table 3.11 implies that of the students who were in the victimized class in grade 6, 31% transitioned into the sometimes-victimized in grade 7. Looking at the two transition tables in Table 3.11 shows that when students transition they tend to transition into a victimization class with a lower frequency of victimization. This is evident by comparing, for example, the transition probabilities of students in the sometimes-victimized class in grade 6 who transition out of the sometimes-victimized class. These values indicated that of the students who transitioned (i.e., students who did not remain in the sometimes-victimized class for both grades 6 and 7), 48% transitioned to the nonvictimized class in grade 7, while 18% transitioned to the victimized class. The overall pattern indicates that

when transitions occur, students were more likely to transition into a class with less victimization¹⁵. This pattern was observed for both transition points.

Looking across the matrices presented in Table 3.11, there are some interesting patterns. There is more stability for those in the victimized class from grades 6 to 7 than those in the victimized class from grades 7 to 8 (i.e., 0.46 compared to 0.19, respectively). Students in the sometimes-victimized class are more likely to transfer to the nonvictimized class between grades 7 to 8 than to transfer between grades 6 to 7. In general, comparing across the matrices in Table 3.11, more stability in victimization is observed for the nonvictimized class than for the other classes. Further, even though students show a tendency to transition to a class with less victimization between grade 6 and 7, the movement is more evident in the transition between grades 7 and 8.

Measurement Invariance

As described in Chapter 2, measurement invariance involves equality assumptions to be made regarding the relationship between the observed items and the latent variable. In this study, exploring measurement invariance involves testing the how reasonable it is to assume that the structure of the three victimization classes are similar enough across time to be considered the same. As noted, the 3-class LCA solution consistently emerged for each grade, and the profiles of the three classes appeared consistent across grades. Formal measurement invariance testing, in the form of likelihood ratio tests (LRTs), is used to assess statistically the plausibility of measurement invariance. Assuming full measurement invariance facilitates straightforward discussions about transitions among the victimization classes because the victimization classes are always the same across time. While measurement

¹⁵ Note that this sort of summary is only useful when you have an ordering to the classes.

invariance implies that the structure of the classes is the same across time, it does not impose any restrictions on the size of the class.

Chapter 2 described several stages for testing measurement invariance that range in the amount of invariance assumed. *Full measurement invariance* assumes that all measurement parameters are the same for each of the three classes, across all three grades of data. *Full measurement noninvariance* makes no assumptions about equality of the measurement parameter across the three classes and grades. *Partial measurement invariance* is a middle ground between full- and non-measurement invariance, but still involves some invariance assumptions. To determine which measurement invariance specification is appropriate, models with varying degrees of measurement noninvariance specifications were fit and compared using log likelihood ratio tests (LRTs).

Full measurement invariance. To begin, a model that has complete measurement invariance was compared to one with complete measurement noninvariance. Thus, two models were estimated, and the LRT results indicated a significant difference in fit between the models. Specifically, the model with complete measurement noninvariance (i.e., all the measurement parameters differ across time) significantly improved model fit. In this application, complete measurement noninvariance implies that all the item probabilities for the three classes may be different across time. As seen in the item profile plots of the three classes across the grade, the profiles of the classes are remarkably similar, providing evidence that some level of measurement invariance assumption could be applied.

Partial measurement invariance. There are many different partial measurement invariance specifications available, especially with three measurement occasions and three classes at each time point. For example, one partial invariance model could be one that allows the

nonvictimized class to be estimated freely across time while the other two classes are invariant (i.e., allowing the structure of the victimization class to be time-specific). Another partial invariance model could be one where one item within a class was noninvariant across time (i.e., to allow for differential item functioning with respect to time) while all the rest of the parameters were held invariant. Because there are so many partial measurement invariance specifications possible with respect to the measured items, classes and time points, the choice of which models to be chosen should be driven not only by statistical evidence that a particular model improves fit, but also that the invariance strategy makes sense in the context of understanding peer victimization. Otherwise, there are many potential partial invariance strategies that could be tested, which could lead to over testing the data.

Several partial invariance models were specified and compared to the full invariance model using LRT methods. The partial invariance models considered were as follows: a model that allowed DIF for two items within the sometimes-victimized class across time, a model that allowed all the item parameters (i.e., not just one or two as with DIF) to be noninvariant for the nonvictimized class while the others were held invariant, and a model that allowed the sometimes-victimized class to be noninvariant only in grade 8. While results indicated statistical improvement in fit for all of the partial invariance models compared to the full invariance model, no model stood out as a better fitting model. In other words, there was no one particular partial measurement invariance model that appeared the most reasonable among those considered.

As a result of not finding a clear partial measurement invariance model that made both statistical and practical sense, full measurement invariance was assumed. This

assumption was supported by the fact that the item profile plots were remarkably similar across groups and across time. Further, the covariate and distal outcome results indicated consistent relationships for the three classes across all three grades. In a practical sense, assuming full measurement invariance allows meaningful comparisons to be made about the classes across time. More research on measurement invariance in LTA models is needed to understand the implications of the measurement invariance assumption on the model.

Comments. This step involved using the cross-sectional LCA results to create cross-tabulations to summarize movement in and out of the three victimization classes. A decent amount of stability in the victimization classes was observed. Further, a consistent pattern of change emerged: if a student were to transition, he or she would most likely have transitioned into a lower victimization class. This was consistent with the results observed in Step 1 when it was noted that the size of the victimization class was decreasing while that of the nonvictimized class was increasing.

The applicability of measurement invariance assumptions was also explored in this step. It is important to explore measurement invariance of the classes before imposing structure on their relationship across time (i.e., through the autoregressive relationship). Despite results indicating an improvement in fit by allowing partial noninvariance, without strong support for one particular partial measurement noninvariance model, full invariance seems reasonable only given the consistency of the item profile plots across time. The full measurement invariance could pose as a potential limitation of the study, because it may mask important developmental differences exist but were ignored.

Step 3: Explore Specification of the Latent Transition Model without Covariates

This step is the first one that involves a longitudinal model. First, an unconditional Latent Transition Analysis (LTA) model that does not include covariates is considered, a logical starting point in estimating a model that has many components. In HLM models, this is often referred to as estimating the unconditional growth model (Raudenbush & Bryk, 2002). This step explores specification issues relating to stationarity of transition probabilities and the applicability of a higher order effect.

Transition Probabilities: Stationary or Not?

The stationary assumption in LTA modeling relates to the equality of transition probabilities across each of the transition points (e.g., grade 6 to 7 and grade 7 to 8). If a process is assumed stationary, transition probabilities are constrained to be the same across time. In other words, the transition matrices are the same across all the transition points, implying that students' probability of transitioning among the victimization classes remained constant throughout middle school.

Two different LTA models were fit to study if stationary transitions were reasonable. One model estimated a transition matrix for each transition point (e.g., one for grade 6 to grade 7 and another for grade 7 to grade 8), and a second model constrained the transition matrices to be the same across the two transition points. The likelihood ratio test (LRT) indicated no significant worsening in fit if stationarity was imposed ($\chi^2_{(df=6)} = 5.45, p = 0.49$). In other words, there were no significant differences in the transition probabilities across the two transition points, implying that students were equally likely to move out of the victimization class into the less frequently victimized classes across the two transition points. Table 3.12 displays the transition probabilities for the model with and without stationary

transition matrices. While there were some minor differences in the transition probabilities, there did not appear to be any particular transition probability that changed substantially when imposing a stationarity constraint.

Table 3.12. Transitions probabilities for the stationary (left panel) and non-stationary (right panel) LTA models

Stationary				Non Stationary			
Grade 7				Grade 7			
Grade 6	VI	SV	NV	Grade 6	VI	SV	NV
VI	0.46	0.40	0.15	VI	0.42	0.41	0.17
SV	0.06	0.48	0.45	SV	0.05	0.48	0.47
NV	0.01	0.08	0.91	NV	0.01	0.10	0.90

Grade 8				Grade 8			
Grade 7	VI	SV	NV	Grade 7	VI	SV	NV
VI	0.46	0.40	0.15	VI	0.52	0.38	0.11
SV	0.06	0.48	0.45	SV	0.07	0.49	0.44
NV	0.01	0.08	0.91	NV	0.01	0.06	0.92

Note: VI class = victimized class, SV class = sometimes-victimized class, NV class = nonvictimized class

As pointed out in Chapter 2, the stationarity specification is only relevant for models that do not consider covariates, but is included in this chapter as an example of how to test for stationarity. Since this application will include covariates and distal outcomes in the model, stationarity would not be reasonable.

Exploring First- and Second-Order Transitions

In most applications of the LTA model, only first-order effects (i.e., lag-1 effects) are considered. This implies that adjacent outcomes are directly related, and nonadjacent outcomes are only related indirectly. It is not necessary to limit the relationship of the outcomes to be first-order, especially when there is a developmental reason suggesting otherwise. Higher-order relationships are possible and allow outcomes to be related in

different ways, depending on the number of time points. For example, second-, third-, or even higher-order effects are possible when many time points are considered.

Figure 3.4 displays an LTA model diagram with a first-order (i.e., arrow between C_1 and C_2 and between C_2 and C_3) and a second-order effect (i.e., arrow between C_1 and C_3). In this study of peer victimization, a second-order effect allows for a direct effect of grade 6 victimization experiences on students' trajectories. Thus, the second-order effect would uncover to what extent grade 8 victimization experiences directly relate to grade 6 victimization, above the relationship through grade 7. Because there are only three time points, the highest order effect possible is a second-order.

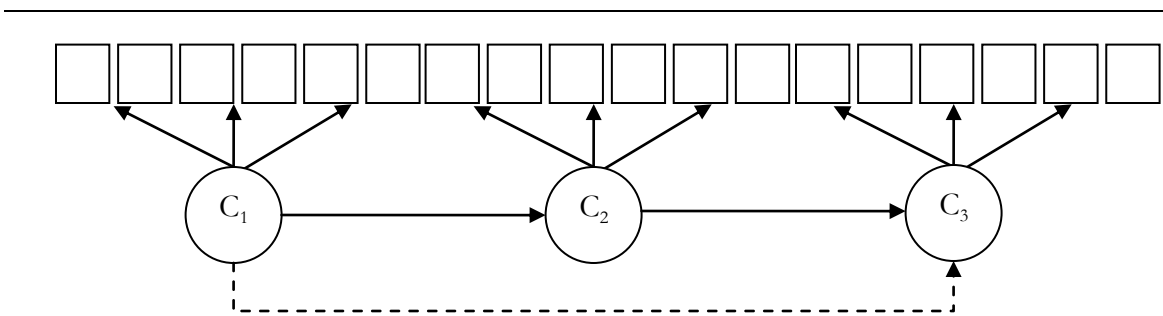

Figure 3.4. LTA model with first-order effect (arrow with straight connector lines) and a second-order effect (arrow with dashed connector line).

To explore if a second-order effect is relevant in this application, two models were fit: an LTA model with an estimated first-order effect and an LTA model with a first- and second-order effect. The LRT comparing fit of these two models indicated that the model with the second-order transition provided a significantly better fit ($\chi^2_{(df=4)} = 38.2, p < 0.01$). A further indication that the second-order effect was relevant in this application is that the number of significant bivariate residuals decreased 5% when the second-order effect was added. For the sake of pedagogy, Table 3.13 presents the transition probabilities for the first-

order model as well as the transition probabilities for the model that included a first- and a second-order effect. The transition probabilities for the LTA model with the second-order are the first-order probabilities, adjusted for the second-order effect.

Table 3.13. First-order transition probabilities for both the first-order LTA model (left panel) and the first- and second-order (right panel) LTA models where the transition probabilities are adjusted for the second-order effect

First-Order Only				First- and Second-Order			
Grade 7				Grade 7			
Grade 6	VI	SV	NV	Grade 6	VI	SV	NV
VI	0.42	0.41	0.17	VI	0.42	0.37	0.22
SV	0.05	0.48	0.47	SV	0.06	0.45	0.49
NV	0.01	0.10	0.90	NV	0.01	0.10	0.89

Grade 8				Grade 8			
Grade 7	VI	SV	NV	Grade 7	VI	SV	NV
VI	0.52	0.38	0.11	VI	0.48	0.39	0.13
SV	0.07	0.49	0.44	SV	0.05	0.47	0.48
NV	0.01	0.06	0.92	NV	0.03	0.08	0.90

Note: VI class = victimized class, SV class = sometimes-victimized class, NV class = nonvictimized class

As expected, when comparing the transition probabilities in Table 3.13 across the two models, the major difference between the two models emerges when looking at the second transition point (grade 7 to grade 8). The values on the diagonal are smaller than the diagonal values in the first-order model because these probabilities are adjusted for the lasting effect of victimization that occurs in grade 6.

Another, perhaps clearer, way to see the impact of the second-order effect on the transition probabilities is to look at the relationship between grade 6 victimization classification and grade 8 victimization classification. This is achieved by presenting the transition matrices for grade 7 to grade 8 according to the classification of the student in

grade 6. Table 3.14 includes three grade 7 to grade 8 transition matrices, presented by a students' victimization class in grade 6.

Table 3.14. Transition matrices for grade 7 to grade 8, presented by victimization class in grade 6 based on an LTA model with a second-order effect

		Grade 8		
Grade 6	Grade 7	VI	SV	NV
VI Class	VI	0.57	0.34	0.09
	SV	0.13	0.53	0.34
	NV	0.16	0.16	0.69

		Grade 8		
	Grade 7	VI	SV	NV
SV Class	VI	0.21	0.59	0.20
	SV	0.03	0.52	0.45
	NV	0.03	0.14	0.83

		Grade 8		
	Grade 7	VI	SV	NV
NV Class	VI	0.15	0.34	0.51
	SV	0.01	0.21	0.78
	NV	0.01	0.04	0.95

Note: VI class = victimized class, SV class = sometimes-victimized class, NV class = nonvictimized class

The transition matrices in Table 3.14 show the impact of grade 6 victimization experiences on later victimization. Many comparisons of the transition probabilities in Table 3.14 highlight the persistent effect of grade 6 victimization, using the transition matrices in Table 3.14. For example, there is a markedly higher probability of a student transitioning in the VI class in grade 8 from the SV (0.13) or NV (0.16) class in grade 7, if that student was in the VI class in grade 6, than there would be if the student was in the SV (both 0.03) or NV (both 0.01) classes in grade 6. Also, students who were in the VI class in grade 6 are

nearly four times more likely to remain in the VI class if they were in the VI class in grade 7 (0.57), compared to students in the NV class in grade 8 (0.15).

Another way to explore the impact that early victimization experiences have on a students' trajectory is to look at the transition probabilities from grade 6 to grade 8, collapsing over grade 7. Thus, the values in Table 3.15 describe the probability that a student ended up in one of the victimization classes in grade 8 given their victimization class in grade 6, regardless of the student's victimization experience in grade 7.

Consider the value of 0.27 in the transition matrix for the first-order model in Table 3.15. This value indicates that of the students who were in the victimized class in grade 6, 27% remained in the victimized class in grade 8, regardless of which victimization class they were in during grade 7. This value is based on three possible developmental patterns across grades 6, 7 and 8: (VI, VI, VI), (VI, SV, VI), and (VI, NV, VI).

Table 3.15. Transition probabilities for grade 6 to grade 8, collapsing over grade 7, using an LTA model with only a first-order effect (left panel) and using an LTA model with both a first- and second-order effects (right panel)

First-Order only				First- and Second-Order Effect			
Grade 8				Grade 8			
Grade 6	VI	SV	NV	Grade 6	VI	SV	NV
VI	0.27	0.37	0.36	VI	0.32	0.37	0.31
SV	0.06	0.29	0.65	SV	0.04	0.34	0.62
NV	0.02	0.10	0.88	NV	0.01	0.06	0.93

Note: VI class = victimized class, SV class = sometimes-victimized class, NV class = nonvictimized class

The results in Table 3.15 again show the lasting impact of grade 6 victimization experiences on students' trajectories. Regardless of what happened to those students in grade 7 (i.e., victimized or not), 93% of the nonvictimized (NV) students in grade 6 remained in

the nonvictimized class in grade 8. Considering the other extreme, students who were in the victimized class in grade 6 had nearly an equal chance of ending up in any of the three victimization classes at grade 8. Comparing the transition matrices presented in Table 3.15, all diagonal values, values that describe stability in victimization experiences are higher for the second-order model.

Thus, broadly speaking, if a student has a history of victimization (i.e., was victimized in grade 6), that student was more likely to be a victim at a later time point, regardless of whether that student experiences a period without being victimized, than those without a history of victimization. Further, if a student has an early experience of not being victimized, that student is more likely to end up nonvictimized in grade 8, regardless of the student's victimization experience in grade 7.

Comments. This step explored different model specifications to determine what sort of models may be needed in future steps. The stationary assumption was tested for this example, and no significant difference in fit between the model that assumed a stationary process and the one that did not was found. Regardless of these results, in applications that intend to incorporate covariates, a stationary assumption should not be imposed. This is because when covariates are included in the model, a stationary change process is not reasonable, because the transition probabilities are no longer conditioned only on the previous time point, but on the covariates as well. This step was included in the analysis to show how stationarity could be explored for LTA models that do not use covariates, or LTA models that use multiple groups to explore differences across values of a categorical covariate. Finally, a second-order effect was important for this application, implying a lasting effect of grade 6 victimization experiences.

Exploring each potential model specification is an important step in building the larger model, because the specifications directly influence results. Also, exploration of the models as a first step, without covariates, is a good rule of thumb because models become more complicated when complex covariate relationships are specified.

Step 4: Include Covariates in the LTA Model

The inclusions of covariates in the LTA model can describe heterogeneity in the developmental process being studied (Humphreys & Janson, 2000). In this step, both observed and latent covariates are considered. There are two types of observed covariates included in this application, time-varying and time-invariant. The time-varying covariates are variables measured repeatedly at the same time as the outcome (e.g., social anxiety, depressive feelings, and school safety). The time-invariant covariates are the demographic variables that are only measured once (e.g., gender and ethnicity). For both time-varying and time-invariant covariates, we can estimate either time-varying or time-invariant effects. A time-varying covariate effect allows for the differential impact of a variable over time. For example, a time-varying effect of depression on the victimization classes would allow for interpretation of whether depression relates to the victimization classes differently over time. In this study, both time-varying and time-invariant covariates have time-varying effects.

A latent covariate is a latent variable that describes unobserved heterogeneity in the transitions. This step includes a higher-order latent variable specified as a mover-stayer variable. This second-order mover-stayer variable has two classes: one class of students who move among the victimization classes, called “movers,” and another class of students who remain in their victimization class throughout middle school, called “stayers.” Other

restrictions on this higher-order latent variable are possible and allow for different kinds of movers and stayers.

To illustrate the impact of a covariate on transition probabilities, an LTA model with a single covariate of gender was estimated. Gender was allowed to have a time-varying effect, which implies that for each time point gender was allowed to affect the class variable differently. This resulted in an additional two parameters being estimated for gender at each time point, one for the victimized and one for the sometimes-victimized class. These parameters are used to assess the change in the log odds of being in either the victimized or the sometimes-victimized class, compared to the nonvictimized class (the reference class). This model was a first-order model that did not assume stationary transition probabilities (i.e., the transition probabilities were different for the two transition points).

Table 3.16. Logistic regression coefficients for LTA model with time-varying gender effect with non-stationary transitions and a first-order effect

<i>Class</i>	<i>Effect</i>	<i>Coefficient</i>	<i>S.E.</i>	<i>Z</i>	<i>P-value</i>	<i>Odds Ratio</i>
Victimized	Female	-0.58	0.23	-2.49	0.01	0.56
Sometimes-victimized	Female	-0.04	0.18	-0.21	0.84	0.96
Victimized	Female	-0.18	0.36	-0.50	0.62	0.83
Sometimes-victimized	Female	-0.27	0.16	-1.69	0.09	0.76
Victimized	Female	-0.13	0.29	-0.45	0.65	0.88
Sometimes-victimized	Female	-0.22	0.21	-1.05	0.29	0.80

Table 3.16 displays the gender effect estimates for this LTA model. Several important points from the above table merit discussion. Comparing the time-varying effects of gender across grades, there was, in fact, a time-varying effect. The gender logistic regression coefficient for sixth grade (-0.58, $p < .001$) indicated that being female instead of

male decreased the odds of being in the victimized class relative to the nonvictimized class. However, this result was not observed for the subsequent grades. The female logistic regression estimates for grades 7 and 8 were not significant, which indicated that for grades 7 and 8, male and female students were equally likely to be in all three victimization classes.

Categorical covariates allow for a straightforward comparison of transition matrices because the transition matrix is the same for everyone in each of the categories of the covariate (e.g., males and females). The transition probabilities allow us to not only compare transition probabilities across transition points (i.e., grade 6 to 7 can be compared to grade 7 to 8), but also across gender.

Table 3.17. Estimated transition probabilities presented by gender (males on the left, females on the right) based on model with only gender as a covariate

Males Grade 7				Females Grade 7			
Grade 6	VI	SV	NV		VI	SV	NV
VI	0.42	0.42	0.16	VI	0.42	0.38	0.19
SV	0.05	0.51	0.44	SV	0.05	0.44	0.51
NV	0.01	0.11	0.88	NV	0.01	0.09	0.91

Males Grade 8				Females Grade 8			
7th Grade	VI	SV	NV		VI	SV	NV
VI	0.51	0.39	0.10	VI	0.52	0.37	0.11
SV	0.07	0.51	0.42	SV	0.07	0.46	0.47
NV	0.02	0.07	0.91	NV	0.01	0.06	0.93

Note: VI class = victimized class, SV class = sometimes-victimized class, NV class = nonvictimized class.

As seen in Table 3.17, there were no clear differences across transition points. The transition probabilities in each of the cells were rather close across the two transition points

for both genders. This was expected though, because in the previous step there was not a strong signal indicating that estimating a transition matrix for each time point was necessary.

Even though the effect of gender was not significant, there were still interesting differences in the estimated transition probabilities when comparing males and females. Considering the first transition point, and comparing males and females in Table 3.17, the probability of remaining in the victimized class was about the same across gender (42% for both males and female students). Female students were more likely to transition down to the nonvictimized class (19%) than the male students (15%). When comparing the transition probabilities across time for both male and female students, the stability probabilities for the extreme groups (e.g., the VI and NV classes) were higher during the second transition point.

LTA Model with Continuous Covariates

So far, only the gender covariate has been considered, but there are other covariates that are also of interest in this study. Students' feelings of social anxiety, school safety, gender, and ethnicity are all included in an LTA model that builds on previous decisions. The next LTA model fit included a second-order effect and did not assume stationary transition probabilities. All of the covariates were allowed to have time-varying effect on the classes.

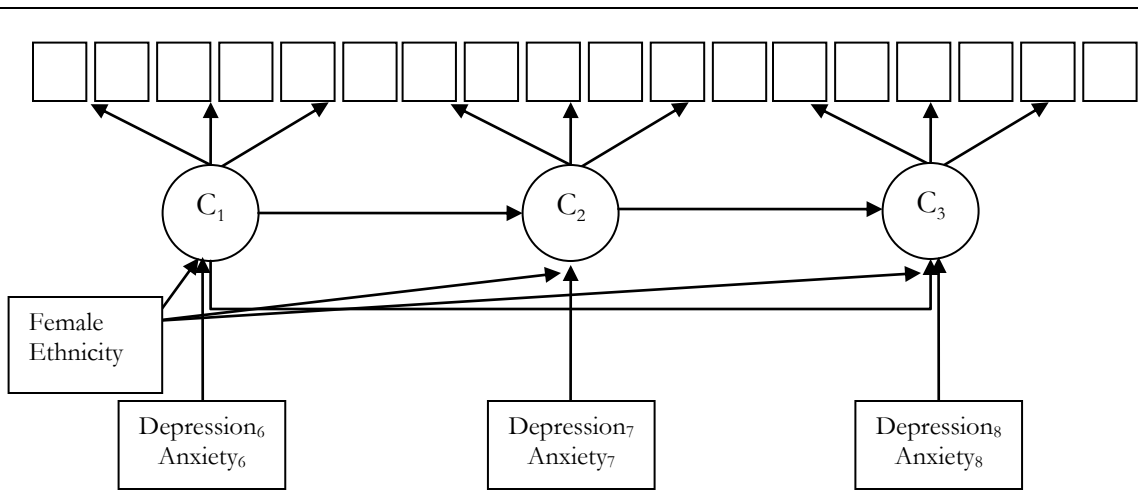

Figure 3.5. Model diagram of the LTA with first- and second-order effect, non-stationary transition probabilities, and time-varying effects of covariates.

Figure 3.5 displays the LTA model with both categorical (i.e., female and the ethnicity dummy variables) as well as continuous covariates (i.e., anxiety and school safety). This model does not assume stationary transition probabilities, and therefore different transition probabilities are estimated at each transition point.

Model estimates are presented in Table 3.18. Anxiety and school safety had similar effects across all three grades. The anxiety logistic regression coefficient for sixth grade (0.81, $p < .001$) indicated that for a one-unit increase in feelings of anxiety, there is a significant increase in the odds of being in the victimized class compared to the nonvictimized class. That is, students who felt more anxious had an increase in the odds of being in the victimized class compared to the nonvictimized class. A similar effect was found when comparing the sometimes-victimized class to the nonvictimized class; students who felt more anxious were significantly more likely to be in the sometimes-victimized class compared to the nonvictimized class, after controlling for gender, ethnicity, and school safety. This result was consistent across all three grades.

Table 3.18. Logistic regression coefficients for 3-class model with anxiety, school safety, gender (boys = 0, girls = 1), and ethnicity covariates where the nonvictimized class is the comparison based on the second-order LTA model

	<i>Effect</i>	<i>Coefficient</i>	<i>S.E.</i>	<i>Z</i>	<i>P-value</i>	<i>Odds Ratio</i>
Grade 6						
Victimized	Anxiety	0.81*	0.15	5.57	0.00	2.25
	Sch. Safety	-2.03*	0.25	-8.27	0.00	0.13
	Female	-0.52	0.28	-1.89	0.06	0.60
	Latino	0.96*	0.30	3.22	0.00	2.60
	African American	1.20*	0.37	3.22	0.00	3.32
	Asian	-0.35*	0.21	-1.70	0.04	0.70
	Biracial	-0.29	0.49	-0.60	0.28	0.75
Sometimes-Victimized	Anxiety	0.53*	0.17	3.20	0.00	1.70
	Sch. Safety	-1.28*	0.29	-4.46	0.00	0.28
	Female	0.21	0.15	1.42	0.15	1.24
	Latino	0.37	0.32	1.14	0.25	1.44
	African American	0.70*	0.30	2.36	0.02	2.01
	Asian	-0.31	0.33	-0.92	0.36	0.74
	Biracial	-0.05	0.35	-0.14	0.89	0.95
Grade 7						
Victimized	Anxiety	0.43*	0.19	2.31	0.02	1.54
	Sch. Safety	-1.52*	0.17	-9.04	0.00	0.22
	Female	-0.44	0.36	-1.20	0.23	0.65
	Latino	0.10	0.66	0.15	0.88	1.10
	African American	0.99	0.72	1.39	0.17	2.70
	Asian	0.85	0.85	1.00	0.32	2.33
	Biracial	0.72	0.86	0.84	0.40	2.06
Sometimes-Victimized	Anxiety	0.62*	0.11	5.56	0.00	1.85
	Sch. Safety	-0.62*	0.16	-3.89	0.00	0.54
	Female	-0.43	0.24	-1.84	0.07	0.65
	Latino	0.12	0.42	0.29	0.77	1.13
	African American	0.69*	0.32	2.14	0.03	2.00
	Asian	0.45	0.60	0.75	0.45	1.57
	Biracial	0.57	0.46	1.22	0.22	1.76

Grade 8						
Victimized	Anxiety	0.92*	0.33	2.80	0.01	2.50
	Sch. Safety	-0.99*	0.44	-2.24	0.03	0.37
	Female	-0.05	0.36	-0.13	0.90	0.96
	Latino	-0.24	0.73	-0.32	0.75	0.79
	African American	-0.04	0.58	-0.07	0.94	0.96
	Asian	-0.61	0.61	-1.00	0.32	0.54
	Biracial	0.00	1.10	0.00	1.00	1.00
Sometimes-Victimized	Anxiety	0.76*	0.24	3.12	0.00	2.14
	Sch. Safety	-0.19	0.55	-0.35	0.72	0.82
	Female	-0.36	0.27	-1.33	0.18	0.69
	Latino	-0.76*	0.18	-4.16	0.00	0.47
	African American	-0.40*	0.19	-2.14	0.03	0.67
	Asian	-1.28*	0.29	-4.37	0.00	0.28
	Biracial	-0.29	0.42	-0.69	0.49	0.75

There was a significant school safety effect for both the victimized and sometimes-victimized classes as compared to the nonvictimized class. The school safety logistic regression coefficient for fall of grade 6 (-2.03, $p < .001$) indicated there was a significant difference in feelings of school safety for students in the victimized class compared to the nonvictimized class. Specifically, for a one-unit increase in feelings of school safety, the odds of being in the victimized class compared to the nonvictimized class decreased, after controlling for gender, ethnicity, and anxiety. Similar results were found for the sometimes-victimized class; students who felt safer in school were more likely to be in the sometimes-victimized class compared to the nonvictimized class, after controlling for gender, ethnicity, and anxiety. This result is consistent across all three grades. Interestingly, there were consistently no gender differences across all grades once ethnicity, anxiety, and school safety were included in the model. This implied that female students were equally likely to be in any of the three classes after controlling for the other covariates.

Higher-order Latent Class Variable: The Mover-Stayer Variable

The inclusion of a higher-order latent class variable, such as a mover-stayer second-order latent class variable (described in Chapter 2), is one way to capture unobserved heterogeneity in the transition probabilities. In the current application, the mover-stayer variable is of interest because it will identify students who experience chronic victimization throughout middle school. A *mover* is a student who transitions at least once in or out of a victimization class in middle school (e.g., one possible mover pattern would be: VI, NV, NV). A *stayer* is a student who remains in the same victimization class throughout middle school (e.g., SV, SV, SV, or NV, NV, NV). The mover-stayer variable differentiates between students who remain in the same victimization class throughout middle school from students who show at least one transition. By separating out the movers from the stayers, we more accurately estimate the transition probabilities for those students who move, if in fact there are students who have zero probability of moving among the victimization classes (i.e., stayers). The mover-stayer specification of the higher-order latent variable is relevant in this application because the same number and type of latent classes emerged across all three grades.

The mover-stayer LTA model that was estimated did not include observed covariates or assume stationary transitions and only included a first-order effect. There are several patterns worth noting. Table 3.19 presents the percent of students in each of the three classes based on this model. The class size pattern that was observed in Step 2 is again noted here, where the size of the victimization class decreases from 21% in grade 6 to 10% in grade 8, while the nonvictimized class increases from 47% in grade 6 to 71% in grade 8.

Table 3.19. Percent of students in each class in grades 6 through 8 based on the mover/stayer LTA model without covariates

Classes	Grade 6	Grade 7	Grade 8
VI	21%	12%	10%
SV	32%	26%	19%
NV	47%	63%	71%

Note: VI class = victimized class, SV class = sometimes-victimized class, NV class = nonvictimized class.

Table 3.20 presents the most frequent patterns (those that had a frequency larger than 10) of transitions for the mover-stayer model. Fifty-two percent of the sample was classified as movers, while 48% were stayers. The most common pattern for students classified as movers were those who were sometimes-victimized in grade 6 and then moved into the nonvictimized class and remained there for grades 7 and 8 (i.e., the pattern of SV, NV, NV), which comprised 9% of the total sample. The next largest pattern among the movers (8%) was for students in the sometimes-victimized class for grades 6 and 7, who then transitioned into the nonvictimized class at grade 8. These two patterns were similar to a finding observed before; when students change victimization class, they were likely to transition to a less frequently victimized class. The remaining patterns for students classified as movers exhibited a variety of different patterns. For example, 10 students (1% of the sample) who were in the victimized class at grade 6 transitioned into the nonvictimized class at grade 7, and then transitioned back in the victimized class in grade 8 (i.e., the VI, NV, VI pattern).

Table 3.20. Percent of students in each pattern of victimization of experiences, ordered by the largest to smallest pattern for movers and stayers

	Pattern			Count	Percent
	Grade 6	Grade 7	Grade 8		
Movers	SV	NV	NV	183	9%
(52%)	SV	SV	NV	161	8%
	SV	SV	SV	89	4%
	SV	NV	SV	82	4%
	VI	SV	NV	77	4%
	VI	NV	NV	76	4%
	VI	SV	SV	51	2%
	NV	SV	NV	44	2%
	NV	NV	NV	43	2%
	VI	NV	SV	37	2%
	SV	VI	NV	27	1%
	NV	SV	SV	24	1%
	NV	NV	SV	22	1%
	SV	VI	SV	22	1%
	VI	VI	NV	21	1%
	VI	VI	SV	16	1%
	SV	SV	VI	16	1%
	SV	NV	VI	15	1%
	VI	NV	VI	10	1%
Stayers	NV	NV	NV	808	40%
(48%)	VI	VI	VI	128	6%
	SV	SV	SV	50	2%

Note: VI class = victimized class, SV class = sometimes-victimized class, NV class = nonvictimized class.

The largest class among those classified as stayers, found in Table 3.20, were those students who remained consistently nonvictimized throughout middle school. These students comprised 40% of the sample. The next largest group (6%) was the chronically victimized class, and the smallest class of the stayers (2%) was the students who remained in the sometimes-victimized class.

Mover-stayer LTA Model with Covariates

The previous mover-stayer LTA model did not include covariates or distal outcomes. There are several covariates of interest in this application. Thus, the next mover-stayer LTA model considered included relevant covariates. Because of the strict stationarity assumption imposed for the stayers, the covariates were only related to the students in the mover class. Gender was included in the model and allowed to influence both the mover-stayer latent class variable, as well as to have a time-varying influence on the time-specific latent class variable, as depicted in Figure 3.6. Three continuous time-varying covariates influenced the time-specific latent class variables and were allowed to have a time-specific effect: feelings of school safety, depression, and anxiety. Two different distal outcome variables were included in the model, and distal outcome means were estimated for students classified as movers and for the three types of stayers.

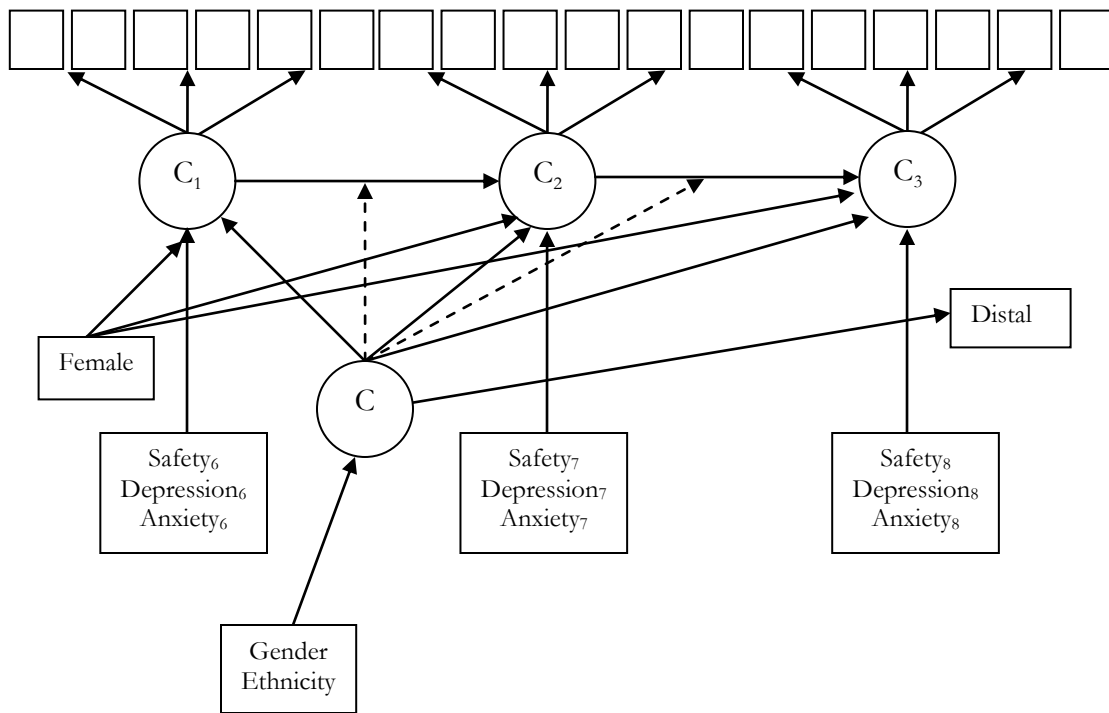

Figure 3.6. Mover-Stayer LTA model with gender and ethnicity, and time-varying covariates depression and anxiety and two distal outcomes.

The results of the model depicted in Figure 3.6 are not presented and interpreted at this point. This is because, though this model presented one way of modeling unobserved heterogeneity in the transitions over time, the higher-order effect (i.e., the second-order effect) was chosen as a more appropriate way to describe the heterogeneity. The mover-stayer approach imposes a strict stayer class where students in that class have a zero probability of transitioning to any other victimization class. This implies, among other things, that students identified as stayers in the nonvictimized class have zero probabilities of being victimized, an overly severe restriction that does not seem plausible in this sample of students. Thus, the model with a higher order effect is a more practical way of describing heterogeneity in victim class transitions.

Comments. This step involved the inclusion of covariates that aid in describing and understanding heterogeneity in the transitions. This step involved two types of covariates: observed and latent covariates. Of the observed covariates, both time-varying and time-invariant covariates were allowed to have time-varying effects. Important time-varying covariate effects emerged. The latent covariate was a higher order latent class variable specified to be a mover-stayer latent variable. A model that included both the mover-stayer latent variable and observed covariates was presented for the sake of pedagogy. The results of this model were not interpreted in this step because the mover-stayer variable is too restrictive for the study of peer victimization, a decision discussed further in the next step.

Step 5: Include Distal Outcomes and Advanced Modeling Extensions

This last step involves specifying the final LTA Model that builds on information from the previous steps. The final model considered was one that included the important second-order effect, had time-varying transition probabilities, time-varying and time-invariant covariates and two distal outcomes, and which is depicted in Figure 3.5. Specifically, time-varying covariates are included in the model and allowed to have a time-varying effect. Time-invariant covariates (i.e., gender and ethnicity) are allowed to have time-specific effects. Two distal outcomes, physical symptoms and social worries, are included, and their means are estimated for each victimization class membership at grade 8.

The model in Figure 3.7 depicts the final model considered in this application. Building on results from previous steps, this model includes a higher order effect, non-stationary transition probabilities, time-varying covariates that have time-varying effects and a distal outcome that is predicted by a student's victimization status in grade 8.

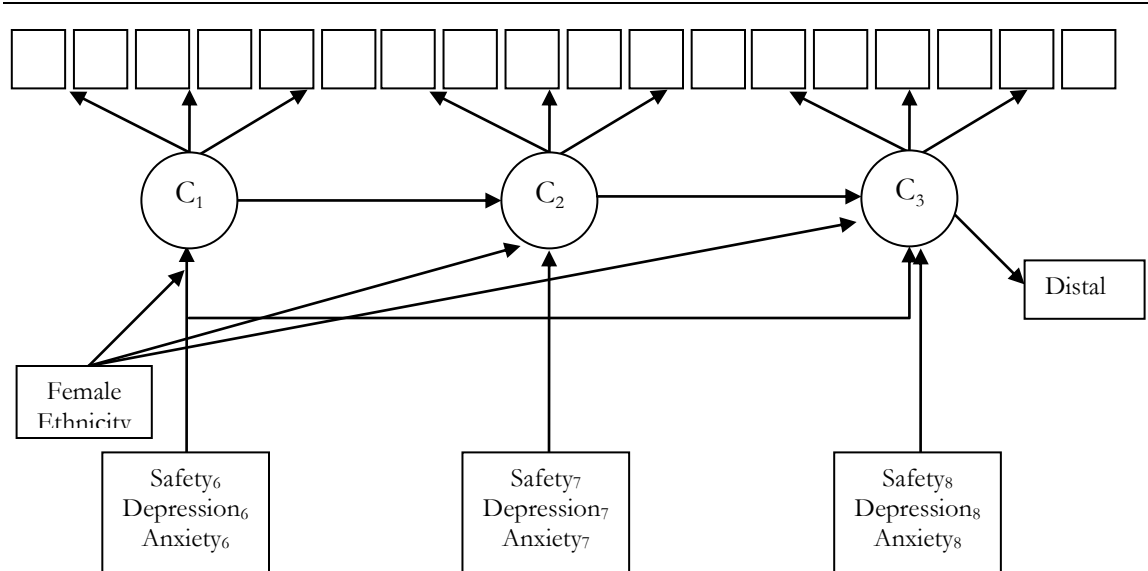

Figure 3.7. Second-order LTA model with gender and ethnicity, and time-varying covariates of depression and anxiety and a distal outcome.

The results of this model are consistent with what has previously been found. The relative sizes of the classes, presented in Table 3.21, showed a transitional pattern consistent with what was observed in previous steps. Specifically, the size of the victimized class decreased from 26% in grade 6 down to 12% in grade 8, while the nonvictimized class increased from 32% in grade 6 to 56% in grade 8. The relative size of the sometimes-victimized class also decreased.

Table 3.21. Percent of students in one of the victimization classes in grades 6 through 8 based on final model

	Grade 6	Grade 7	Grade 8
VI	26%	16%	12%
SV	42%	36%	32%
NV	32%	48%	56%

Note: VI class = victimized class, SV class = sometimes-victimized class, NV class = nonvictimized class.

Table 3.22 presents the associations that the covariates had with students' victimization classifications across middle school. Consistent with the previous model interpretations, the nonvictimized class was the reference class. Thus, two covariate comparisons were made: (a) the likelihood of being in the victimized class compared to the nonvictimized class, and (b) the likelihood of being the sometimes-victimized class compared to the nonvictimized class. Then, these results can be compared across the three grades to note general trends in covariate effects. The value of the model estimates are interpreted for the first covariate presented, social anxiety, but overall summaries of results for the rest of the covariates are presented since the interpretation of the value of the logistic regression coefficient can be easily made.

The results for the covariate of social anxiety in grade 6 showed differential effects among the victimization classes. The social anxiety logistic regression coefficient for grade 6 (0.46, $p < 0.05$) indicated that a one unit increase in social anxiety resulted in an increase in the odds of being in the victimized class compared to the nonvictimized class. Thus, students in the victimized class reported feeling more socially anxious, controlling for all other covariates. The non-significant logistic regression coefficient for the sometimes-victimized class in grade 6 (0.25, $p > 0.05$) indicated that there was no significant difference in feelings of social anxiety for students in the sometimes-victimized and nonvictimized classes. A similar differentiation in feelings of social anxiety was found in grade 8. Results indicated no significant differences in terms of social anxiety among the three victimization classes in grade 7.

There were significant depression and school safety effects for both the victimized and sometimes-victimized classes compared to the nonvictimized class. Specifically, students

in both the victimized and sometimes-victimized classes reported significantly more feelings of depression than students in the nonvictimized class, a result that was consistent across middle school. The significant school safety effect for both the victimized and sometimes-victimized classes in grades 6 and 7 indicated that students in the victimized and sometimes-victimized classes reported feeling significantly less safe in school than students in the nonvictimized class, after controlling for the other covariates. This effect, however, did not persist through grade 8, where results indicated that there was no significant difference in feelings among the victimization groups.

The significant gender effect for grade 6 indicated that boys were more likely than girls to be in the victimized class compared to the nonvictimized class, but that boys and girls were equally likely to be in the sometimes-victimized and nonvictimized classes. For grades 7 and 8, boys and girls were equally likely to be in any of the three victimization classes, controlling for the other covariates.

Table 3.22. Logistic regression coefficients for 3-class model with gender (boys = 0, girls = 1), school safety, depression, anxiety and ethnicity covariates, the nonvictimized class is the comparison based on the final LTA model

	<i>Effect</i>	<i>Coefficient</i>	<i>S.E.</i>	<i>Z</i>	<i>P-value</i>	<i>Odds Ratio</i>
<i>Grade 6</i>						
Victimized	Social Anxiety	0.46*	0.12	3.74	0.00	1.58
	Depression	5.00*	2.05	2.44	0.01	148.86
	School Safety	-2.10*	0.62	-3.40	0.00	0.12
	Female	-0.61*	0.26	-2.33	0.02	0.55
	African American	1.41*	0.51	2.76	0.01	4.10
	Latino	0.84*	0.33	2.57	0.01	2.33
	Asian	-0.39*	0.22	-1.81	0.07	0.67
	Biracial	-0.40	0.61	-0.65	0.52	0.67
Sometimes-Victimized	Social Anxiety	0.25	0.17	1.45	0.15	1.29
	Depression	3.66*	1.81	2.02	0.04	38.86
	School Safety	-1.13*	0.57	-1.97	0.05	0.32
	Female	0.03	0.42	0.07	0.94	1.03
	African American	0.79*	0.40	1.98	0.05	2.21
	Latino	0.40	0.23	1.76	0.08	1.49
	Asian	-0.25	0.38	-0.67	0.50	0.78
	Biracial	0.04	0.33	0.13	0.89	1.04
<i>Grade 7</i>						
Victimized	Social Anxiety	0.25	0.25	1.00	0.32	1.28
	Depression	3.79*	1.49	2.55	0.01	44.08
	School Safety	-1.37*	0.27	-5.18	0.00	0.25
	Female	-0.71*	0.29	-2.48	0.01	0.49
	African American	1.16*	0.51	2.30	0.02	3.19
	Latino	0.15	0.53	0.28	0.78	1.16
	Asian	0.77	0.79	0.98	0.33	2.17
	Biracial	0.99	0.58	1.69	0.09	2.68

Table 3.22. (continued).

	<i>Effect</i>	<i>Coefficient</i>	<i>S.E.</i>	<i>Z</i>	<i>P-value</i>	<i>Odds Ratio</i>
<i>Grade 7</i>						
Sometimes-Victimized	Social Anxiety	0.25	0.17	1.48	0.14	1.28
	Depression	3.14*	1.51	2.09	0.04	23.20
	School Safety	-0.40	0.30	-1.33	0.18	0.67
	Female	-0.22	0.27	-0.83	0.41	0.80
	African American	1.04*	0.45	2.33	0.02	2.83
	Latino	0.39	0.42	0.92	0.36	1.47
	Asian	0.41	0.76	0.54	0.59	1.50
	Biracial	0.81	0.44	1.85	0.06	2.25
<i>Grade 8</i>						
Victimized	Social Anxiety	0.52*	0.24	2.13	0.03	1.68
	Depression	3.89*	1.53	2.55	0.01	48.81
	School Safety	-0.98	0.52	-1.88	0.06	0.38
	Female	-0.19	0.41	-0.46	0.65	0.83
	African American	-0.39	0.67	-0.59	0.56	0.68
	Latino	-0.89	0.67	-1.32	0.19	0.41
	Asian	-1.06*	0.47	-2.25	0.02	0.35
	Biracial	-0.78	1.28	-0.61	0.54	0.46
Sometimes-Victimized	Social Anxiety	0.27	0.23	1.19	0.23	1.31
	Depression	3.07*	1.23	2.50	0.01	21.52
	School Safety	-0.58	0.63	-0.93	0.35	0.56
	Female	-0.02	0.27	-0.09	0.93	0.98
	African American	-0.56	0.46	-1.23	0.22	0.57
	Latino	-0.79*	0.29	-2.71	0.01	0.45
	Asian	-0.68	0.44	-1.55	0.12	0.51
	Biracial	-0.38	0.44	-0.88	0.38	0.68

Ethnicity was included in the model using four dummy variables, where Caucasian students were used as the reference group. Results in Table 3.22 indicated that for grades 6 and 7, African American students were more likely to be in the victimized and sometimes-victimized class than the nonvictimized class, compared to Caucasian students. By grade 8,

however, this difference did not persist. Latino students were more likely to be in the victimized class than the nonvictimized class in grade 6 compared to Caucasian students, but equally likely to be in the sometimes-victimized class. For grades 7 and 8, Latino students were just as likely as Caucasian students to be in the victimized class, but in grade 8 were significantly less likely to be in the sometimes-victimized class.

The results for the last two ethnic groups, Asian and Biracial, had very similar results across the grades. Specifically, both Asian and Biracial students were equally likely to be in all three of the victimization classes through middle school as Caucasian students. There was one exception. In grade 8, Asian students were significantly less likely to be in the victimized class than the nonvictimized class, compared to the Caucasian students.

Second-Order Effect

The inclusion of the second-order effect in the final model showed an important relationship between grades 6 and 8 victimization classes. Table 3.23 displays the transition probabilities for grades 6 and 8, collapsed over grade 7 and based on the model with the second-order effect. Results in Table 3.23 indicated that 84% of the students who were nonvictimized in grade 6 returned to being nonvictimized in grade 8, regardless of what victimization experiences they had in grade 7. Further, of the students who were in the victimized class in grade 6, 36% returned to being victimized, and 42% to being sometimes-victimized in grade 8. Comparing all those who ended up in the victimized class in grade 8, results indicated that students who began grade 6 being victimized were 18 times more likely to end up in the victimized class in grade 8 compared to those who were nonvictimized in grade 6, regardless of grade 7 victimization experiences.

Table 3.23. Transition probabilities between grade 6 and grade 8, collapsing over grade 7 for the final LTA model with a second-order effect

Grade 6	Grade 8		
	VI	SV	NV
VI	0.36	0.42	0.23
SV	0.04	0.41	0.55
NV	0.02	0.13	0.84

Note: VI class = victimized class, SV class = sometimes-victimized class, NV class = nonvictimized class.

Distal Outcomes

In the final model, two grade 9 distal outcomes were included and related to students' victimization class in grade 8. This allows for direct relationships between victimization experiences in middle school and outcomes in grade 9. The mean differences in Table 3.24 indicated that students who ended up in the victimized class in grade 8 reported having more physical symptoms and more social worries in high school than students in the nonvictimized class in grade 8. Further, students who were sometimes-victimized in grade 8 were more likely to report having more physical symptoms and more social worries in grade 9 than those in the nonvictimized class.

Table 3.24. Mean (M) and standard deviation (SD) for grade 9 physical symptoms and social worries by grade 8 victimization class

Grade 8 Victimization	Grade 9 Outcomes	
	Physical Symptoms M (SD)	Social Worries M (SD)
VI	1.83 (0.11)	4.55 (0.14)
SV	1.88 (0.11)	4.17 (0.14)
NV	1.56 (0.11)	3.99 (0.14)

Note: VI class = victimized class, SV class = sometimes-victimized class, NV class = nonvictimized class.

Comments. This step involved a culmination of all of the analysis steps presented in this chapter. The decision to use a model with a second-order effect instead of one with a mover-stayer variable was made because the second-order effect provided what was thought to be a more meaningful description of change for the study of victimization. The mover-stayer variable did provide an interesting way to describe chronic victims and consistent non-victims, but was perhaps overly restrictive for students in the stayer class when modeling peer victimization. The choice not to use the mover-stayer variable was specific to the goals of this current application because of the strict restrictions imposed. The mover-stayer variable could be appropriate in other modeling settings.

Results of the final model that included a second-order effect indicated that there was a significant lasting effect of victimization in grade 6, where students who were victimized in grade 6 were much more likely to be victimized by grade 8 than students who were not victimized in grade 6. Further, students who were in the victimized class in grade 8 showed maladjustment problems even after transitioning to high school. Taken together, these results indicate the importance of grade 6 experiences when studying victimization. They also highlight the fact that grade 6 is a critical period during which victimization interventions should take place as a way of preventing students from remaining on a chronic victimization trajectory.

Conclusions

This chapter included a detailed application of the analysis steps of Chapter 2 to study change in self-reported victimization in a sample of middle school students. Several important contributions are made in this chapter. The illustration of the analysis steps from

Chapter 2 in the context of an applied example is a contribution itself. The systematic application of these steps is intended to be general enough to be used in a range of applications. The choice to present results from each of the analysis steps allowed for the demonstration of a complete modeling process that is not commonly seen in the publications using LTA. Further, several innovative LTA modeling extensions were highlighted, including the consideration of alternative measurement models, the inclusion of the higher-order effect, the mover-stayer variable and distal outcomes. The application of these modeling contributions allowed for an innovative study of peer victimization. Chapter 4 synthesizes the modeling results in a broader context of peer victimization.

Chapter 4. Discussion and Conclusions

This chapter provides a review of the material presented in this dissertation. Beginning with a discussion of peer victimization research, the modeling results are summarized to highlight how the findings of the LTA contribute to our understanding of peer victimization. This is followed by a discussion of the modeling contributions that were made in this dissertation, focusing on extensions of the model not commonly seen in other applications. This chapter concludes by discussing possible modeling extensions, opportunities for future work, and other advanced applications of the LTA modeling ideas.

Peer Victimization Results

There were two goals for using LTA to study peer victimization. The first goal was to identify classes of students based on their self-reported victimization experiences. The second was to describe developmental patterns of peer victimization throughout middle school using the LTA model. The following discusses the findings on both of these issues.

Victimization Based on Severity

The results of the current study proved evidence that victimization classes are best understood according to the degree, rather than type, of victimization during the middle school years. These classes emerged using latent class analysis (LCA) that indicated that three, rather than two, distinct classes could describe students' victimization experiences: victimized, sometimes-victimized, and non-victimized. The same three victimization classes emerged across grades 6, 7, and 8. The relative size of the classes suggested that the non-victimized class, the largest class, was the normative class. The sometimes-victimized class was the next largest class, and the victimized class was the smallest. This result persisted

across middle school (i.e., the non-victimized class was always the largest, and the victimized was always the smallest). While the relative ordering of the classes remained the same, the actual size of each class did change over time in a meaningful way. The victimized class decreased over time while the size of the non-victimized class increased, indicating that as students developed throughout middle school they were likely to transition out of the victimized class and into the non-victimized class. This result is consistent with studies that found that victimization is at its highest early on in middle school compared to the other years (e.g., Nansel et al., 2001).

This study incorporated gender and perceived school safety into the LCA analysis as covariates and depression as a distal outcome to evaluate the validity of the classes. These variables were used because of the existence of prior evidence demonstrating consistent associations with peer victimization (Anderman & Kimweli, 1997; Boivin, et al., 1995; Crick et al., 2002). Results indicated that boys and girls appeared to be equally likely to report experiencing a variety of types of victimization during the early part of middle school, but girls were less likely to be in the victimized class later on. Further, results demonstrated that when students perceived their environment to be an unsafe place, they were personally experiencing victimization. The distal outcome results of depression indicated that victimized students were more likely to be depressed than sometimes-victimized and non-victimized students. These findings are consistent with studies of victimization and its links to social stress, feelings of school safety, and depression. Taken together, the results demonstrate that the three victimization classes are meaningful and valid.

Developmental Understanding of Peer Victimization

Three key substantive findings add to the developmental understanding of peer victimization. First, previous cross-sectional findings that indicated a peak in peer victimization in early middle school (e.g., Nansel et al., 2001) were supported with longitudinal data. The normative pattern was for students to move to less victimized classes over time. Patterns of increasing victimization were exceedingly rare. Further, patterns of chronic victimization did occur; however, only a small class of students had this experience.

Second, prior victimization states were associated with maladjustment. A higher-order effect indicated that students' prior victimization experiences in grade 6 were significantly predictive of their victimization experiences in grade 8, over and above their grade 7 experiences. This indicated that there is a lingering effect of early victimization experiences, that lasts two years (i.e., from grade 6 to grade 8), signifying the importance of grade 6 experiences in terms of preventing students' continued feelings of victimization throughout middle school. Further, grade 8 victimization classes predicted maladjustment even into high school (i.e., being victimized in grade 8 led to more physical symptoms and social worries). Thus, grade 6 appears to be a critical time to intervene to prevent feelings of peer victimization and help minimize the likelihood that students will suffer from maladjustment in high school.

Third, the results of the LTA demonstrated time specific effects for the covariates included in the analysis that are typically associated with peer victimization. The gender effect was consistent with what is expected; in grades 6 and 7, compared to girls, boys were more likely to be in the victimized class than the non-victimized class. Depressive symptoms consistently differentiated the victimization classes throughout the course of middle school,

indicating students who were victimized were also more likely to express more depressive feelings than non-victimized students. While findings for school safety and social anxiety were less consistent, they support the idea that students experiencing victimization were more socially anxious and felt considerably less safe in grade 6, when victimization is known to be at its highest in middle school. This finding, however, did not persist through middle school. A lower feeling of school safety was associated with being in sometimes-victimized and victimized classes in early middle school, but not in later years. Combined, these findings suggested that as children become the oldest and biggest in their middle schools, they may be less concerned about safety, but still experienced feelings of personal distress associated with being a victim (e.g., depressive symptoms).

Strengths of LTA to the Study of Peer Victimization

There were many strengths of using LTA to address research questions about the development of victimization experiences throughout middle school. LTA has the ability to define the victimization classes using a measurement model rather than using cut-off points or other methods commonly used in other victimization studies. Further, LTA enables researchers to explore the validity of the classes by using other variables or outcomes that are expected to be related to the victimization classes. This method presented a clear advantage over alternative approaches that a priori assign individuals to victimization classes using cut-offs, and then treats the victimization class status as a known variable. Using LTA, all of the variables included in the analysis (i.e., covariates and distal outcomes) inform the formation of classes as well as influence the change process.

Limitations to the Study of Peer Victimization

There are a few limitations to this study of peer victimization. The current study uses six items to capture peer victimization. It is possible that the model for the victimization classes could have used other, yet to be identified, forms of victimization. Including victimization items that tap into other aspects of victimization than those included might change the classes that emerge. Further, the current study uses data collected in middle school and, as a result, it is unclear whether or not the three victimization classes would emerge once students transition into high school. It may be reasonable to expect the peak in victimization that occurred in grade 6 to occur again directly after the transition to high school, when students are once again the smallest and youngest in their school.

As in any study, more predictors and distal outcomes could have been included to provide a richer depiction of the developmental process than this dissertation explored. This study linked victimization to two outcomes measured in the students' first semester in high school. Future studies could explore additional distal outcomes and integrate measurements from different points in high school, as well as different covariates (e.g., high school climate, social support) that might illuminate the conditions under which the negative consequences of middle school peer victimization persist for students during their high school tenure.

Modeling Ideas and Contributions

This dissertation presented several modeling contributions. One was the use of covariates in the LTA model. Specifically, observed covariates, both time invariant and time-varying, were included in the LTA model and allowed to have time-varying effects on the victimization classes. Had these effects not been allowed to be time-varying, it is possible

that important developmental differences would have been overlooked. For example, the differential effect between students' feelings of safety and the victimization classes suggested that as students progress through school they become more able to adapt to victimization.

The inclusion of covariates was not limited to observed variables. The current application included a latent covariate in the form of a higher-order latent class variable. The covariate was specified to be a mover-stayer latent class variable that helped to explore chronic victimization. Even though this study did not incorporate the mover-stayer variable in the final model, its consideration as a possible latent covariate marked another methodological contribution.

Other modeling contributions include the consideration of alternative measurement models that are available for LTA models. Though LCA was selected as the measurement model, others were described and considered in this application. This study also included a higher-order effect, which allowed the direct relationship between non-adjacent latent class variables to be specified. This is an important extension not commonly seen in LTA applications, mainly due to software restrictions. Including the higher-order effect in this application yielded an important lasting impact of early class membership that otherwise would not have been found. If the higher-order effect had been omitted, the lasting effect of grade 6 victimization would only have emerged indirectly through the first-order effects.

The analysis steps presented in this dissertation highlight another important methodological and pedagogical contribution. The steps were presented in Chapter 2 and then illustrated in Chapter 3, using the study of peer victimization as a concrete application. The analysis steps were designed to aid in the specification of an LTA model, starting from simple descriptive statistics, and eventually building up to a final LTA model that includes

many advanced modeling ideas. The systematic progression through the steps that was presented in Chapter 3 included a discussion of the results of each step and ways in which the results could inform subsequent steps. Further, using the steps to highlight the modeling process allowed for an illustration of some of the decisions that occur in the application of a method to data. The focus on the modeling process using the steps goes beyond what is commonly seen in publications using LTA.

All of the Mplus syntax used to specify the models in this dissertation is included in the appendix. Researchers using LTA models with Mplus can use these input files as example syntax in more general applications. This study presents a wider range of Mplus LTA model specifications than can be found anywhere else.

Modeling Limitations and Future Work

This dissertation intended to provide a pedagogical description of the LTA model and an application that highlights the utility of the model. In order to satisfy these objectives, this study did not consider, or only discussed briefly, certain modeling possibilities. Ideas not considered in the dissertation may be thought of as part of the limitations, but also highlight possibilities for future work.

Generalizability

One specific goal was to provide a comprehensive application of LTA that included discussion of modeling details not commonly found in publications. As such, this dissertation attempted to make the application of the model as general as possible. There are limitations in the generalizability of the application, however, specifically in terms of the interpretation of the parameters and the choice of how to model heterogeneity in transitions.

In terms of the interpretation of the parameters, the current application benefited from the stability in the three victimization classes over time. It is important to note that the consistent three-class solution had advantages in terms of understanding peer victimization and the interpretation of the results, but in some ways limited the discussion of the modeling ideas. Specifically, results from the current study may give the false impression that the same number and type of classes *must* emerge across all time points to use LTA. This is not the case. It is possible to use LTA in settings where either the number of classes or the structure of the classes varies across time. For example, LTA could be used to model change among latent class variables where at one time point there are two classes (e.g., high and low classes) and then at a later time point three (e.g., high, medium, and low classes). In such a situation, the transition tables would be non-symmetric, but nonetheless possible with LTA.

The difference in the number and type of the classes might, in fact, be developmentally relevant. Consider a hypothetical example using the study of peer victimization. It is possible that in grade 6, three victimization classes emerged: victimized, sometimes-victimized, and non-victimized. Then, in grade 7, two classes could have emerged: victimized and non-victimized. Thus, two extreme victimization classes remain constant between those two grades (i.e., victimized and non-victimized), but the sometimes-victimized class distinction that emerged in grade 6 was no longer needed in grade 7. In this hypothetical case, it could be interesting to use LTA to explore which class the sometimes-victimized students transitioned into in grade 7.

Further, in terms of interpreting the transition probabilities, ideas of stability and chronicity discussed in this application most likely will not be relevant when the number and type of classes is not consistent across time. Even when the same number of classes

emerges, it is possible to have differently structured classes (i.e., the profiles of the classes are not the same across time), which would prohibit discussions about stability. Stability relates to an individual's probability of remaining in the same class over time; thus, the results are not meaningful when the classes are not consistent across time. For example, mover-stayer restrictions may not be meaningful since stayers are those who stay in the same type of class over time. When using a higher-order latent variable in an application where the type and structure of classes are different across time, different, more meaningful specifications for the higher-order latent class variable would be used to capture important heterogeneity. Taken together, these considerations imply that there is nothing inherent in LTA requiring that the same number and type of classes across time. Interesting developmental changes may appear when classes are different over time and thus transition probabilities would describe the change among the developmentally relevant classes.

Measurement Models

Though the application in this dissertation considered alternative measurement models, the model eventually used to capture the underlying latent construct was LCA. The use of alternative measurement models holds a lot of promise in the applications of LTA models. Hybrid models that include both a continuous and categorical latent variable may prove to be very useful since they provide a way to classify individuals, while still allowing a degree of within-group variation. Such models use a latent class variable to classify people so that the transition probabilities are still used to describe change among the groups, but these values can be influenced by the continuous factor.

A hybrid measurement model in the context of peer victimization, for example, may result in the same three victimization classes and an additional factor that could represent a

severity dimension. Thus, even within one of the victimization classes, the factor could be used to order students within a given class in terms of their victimization severity. The severity information can be related to students' transition probabilities in order to explore, for example, whether or not students in the victimized class that have low severity scores are more likely to transition into the sometime victimized class compared to students in the same class with high scores.

Measurement Invariance

One area for more work in the LTA framework relates to measurement invariance. Many applications of LTA do not discuss, or give little attention to, the plausibility of measurement invariance, and, as a result, assume full invariance. Depending on the application and the types of measured outcomes, this assumption may be applicable, and in some cases a necessity. In applications that use the measurement model in an exploratory fashion to identify classes that are not known ahead of time, researchers must explore measurement invariance in their studies.

The assumption of full measurement invariance allows for a straightforward comparison of classes and transitions across time. In many situations, assuming measurement invariance significantly reduces the number of parameters estimated. These are not reasons, however, to automatically rely on the assumptions that measurement invariance implies. Little research has focused on understanding the implications on parameter estimates and model interpretation when important measurement differences are ignored, or assumed to not exist. One such measurement difference may be differential item functioning. Partial invariance may be a natural solution in these situations. There are no

clear recommendations for exploring partial measurement invariance since there are numerous ways this invariance can be included in LTA.

Modeling Heterogeneity in Development

Three time points were considered in this application, which spanned a developmentally relevant period for the study of peer victimization. Having so few time points did limit the way in which the study could model heterogeneity in the developmental trajectories. Specifically, a choice had to be made to use either a higher-order effect or a mover-stayer higher-order latent variable. With more time points, it may be possible to include both a higher-order effect and a mover-stayer variable. It is likely that such inclusions would need to be supported by strong substantive theory since there are strict assumptions implied by a mover-stayer variable (i.e., zero probability of transitioning for stayers). However, in theory, it is possible to include both ways of modeling heterogeneity in one application.

LTA Models in a Larger Modeling Framework

This dissertation included an application of the LTA model as a means of describing development using longitudinal data. As a result, attention was given to the many decision processes and analysis steps needed for this type of application. The modeling ideas behind LTA, however, go beyond the study of development in a single outcome over time. The next section describes some of the modeling extensions made possible by placing LTA into a larger modeling framework.

Multiple Processes

This study focused on the single developmental process of peer victimization. As with many other outcomes, change in peer victimization does not occur in isolation. Many other concurrent processes are related to the development of peer victimization and could be modeled simultaneously using multiple process models. In terms of the modeling, a natural extension would be to include other concurrent processes, and possibly another LTA model (or growth model) that simultaneously models change in, say, aggression over time. Such an extension would allow researchers to model relationships across the two processes and use covariates to influence each process, while controlling for change in the other.

LTA Modeling Ideas in a Cross-Sectional Setting

As described in Chapter 2, the ideas behind LTA build on modeling the relationship between two latent categorical variables. LTA uses this framework to model change in repeated measures; thus, it is considered a longitudinal model, but there are many applications where the modeling ideas can be used in a cross-sectional analysis. These models can be explored using log linear modeling, but exploring these relationships using the LTA specifications in Mplus may be considered more straightforward. Consider, for example, two latent class variables each measuring different constructs, say peer victimization experiences (as in the current application) and bully experiences, where the categories of each variable describe a status. The relationships of individuals' statuses for the two constructs can be described using the transition table. The cells of the table would indicate the probability of the different status combinations. The benefits of modeling the relationship of two variables of this nature are that the statuses of each construct can be

defined with relevant items and then the relationships across the constructs could be estimated. Related covariates could be included in either one or both of the constructs.

Applications Without an Exploratory Measurement Model

Applications of LTA models do not have to include a complex measurement model to benefit from this modeling framework. Hidden Markov models, for example, use a single item as an indicator for a latent variable and can easily be specified using this framework. These models benefit from using the latent variable framework since the underlying latent variable represents an error-free representation of the observed item.

Other applications that do not rely on a latent variable measurement model involve latent variables that are combinations of observed indicator variables. The example described in Chapter 2, which involved children's math skill acquisition, used binary variables to indicate if a given skill was observed or not (i.e., child knows how to add or not, child knows how to subtract or not). In these applications, the latent variable is used to indicate which pattern of the indicators is present. In applications like these, the latent class model is used in a confirmatory, rather than exploratory, fashion and the transitions among the classes are expressed in the same way as if the classes were based on an exploratory model.

A range of applications that do not rely on an exploratory measurement model are possible. Modeling change in repeatedly measured ethnic identification is an example of an application without an exploratory measurement model. With the categories of observed variables relating to generic and specific ethnic identification classification, an LTA could describe whether or not students exhibit a pattern of moving from a general ethnic identification to a more specific identification as they mature.

Applications that model change in a binary outcome are also natural applications of LTA where an exploratory measurement model is not needed. Consider an example of a binary outcome that measures students' feelings of discrimination that occur in schools (1 = feeling discriminated against) . Researchers can use LTA to describe different patterns of discrimination experiences throughout middle school. Important covariates may reveal relationships among different groups of students, ethnic groups, or gender groups. Further, school level information can be included to see if discrimination patterns are persistent within certain schools. With binary items as described, using a growth model to describe change in a binary outcome is possible, but LTA could provide different insights into the change in discrimination experiences over time.

Multilevel LTA

The inclusion of multilevel effects into LTA is another natural extension (Asparouhov & Muthén, in press). In the current study, a common clustering variable was not available since students change classrooms throughout middle school. However, when a clustering variable is available, multilevel LTA could uncover important contextual effects. For example, in the context of peer victimization, a multilevel effect could uncover the impact the overall aggressive nature of a classroom has on a student's probability of transitioning among the victimization classes. One could hypothesize that a victimized student in a classroom with an overall high level of aggression is less likely to transition out of the victimized class than is a student in a classroom with a lower level of aggression. Many other applications of multilevel LTA are possible and are likely to reveal interesting and important information about the contextual effect of development throughout middle school.

This dissertation provides a solid example of an application of the LTA model. It includes analysis steps that could be a useful tool for other applied researchers using LTA models. The modeling ideas presented here have enormous potential as stand-alone longitudinal models, as well as part of a larger modeling framework. The flexibility of new longitudinal models has begun to address the complexity inherent in human development. Careful and systematic application of these models can provide unique insight about the nature of social outcomes and suggest new directions for further research.

Appendix A: Description of Variable Names Used in Analyses

To help the reader better understand the syntax provided, and because Mplus only allows variable names up to 8 characters long, a definition for each of the variables used in the syntax is provided.

id = student id

school = indicates which of 11 schools students attend

sex = 0 = male; 1 = female

ethnic = 1 = Caucasian, 2 = African American, 3 = Latino, 4 = Asian, 5 = multiethnic

schsafe6, schsafe7, schsafe8 = school safety composite for grades 6, 7, and 8, respectively

socanx6, socanx7, socanx8 = social anxiety composite for grades 6, 7, and 8, respectively

depress6, depress7, depress8 = depressive symptoms composite for grades 6, 7, and 8

vict1s6 to vict6s6 = 6 individual binary victimization variables for spring of grade 6

vict1s7 to vict6s7 = 6 individual binary victimization variables for spring of grade 7

vict1s8 to vict6s8 = 6 individual binary victimization variables for spring of grade 8

physx9 = physical symptoms composite for grade 9

hs worry9 = social worries in high school for grade 9

Later, the gender and ethnicity variables are recoded/renamed such that:

female: 0 = male, 1 = female

afam: 0 = Caucasian, 1 = African American

latino: 0 = Caucasian, 1 = Latino

asian :0 = Caucasian, 1 = Asian

multi: 0 = Caucasian, 1 = multiethnic

Appendix B: Mplus Syntax for the Factor Analysis Model with 1-Factor

TITLE: Sixth grade 3-class exploratory LCA model

DATA:

FILE is longitdataset.dat;

VARIABLE:

NAMES ARE id school sex ethnic

schsafe6 socanx6 depress6

schsafe7 socanx7 depress7

schsafe8 socanx8 depress8

vict1s6 vict2s6 vict3s6 vict4s6 vict5s6 vict6s6

vict1s7 vict2s7 vict3s7 vict4s7 vict5s7 vict6s7

vict1s8 vict2s8 vict3s8 vict4s8 vict5s8 vict6s8

physsx9 hsworry9;

IDVARIABLE = id;

MISSING are all(9999);

USEVAR = vict1s6 vict2s6 vict3s6 vict4s6 vict5s6 vict6s6;

CATEGORICAL = vict1s6 vict2s6 vict3s6 vict4s6 vict5s6 vict6s6;

CLUSTER = school;

ANALYSIS:

TYPE = general missing complex;

ESTIMATOR= ML;

MODEL:

f1 by vict1s6* vict2s6 vict3s6 vict4s6 vict5s6 vict6s6;

f1@1;

OUTPUT:

TECH10;

Appendix C: Mplus Syntax for the LCA Model with 3-Classes

TITLE: Sixth grade 3-class exploratory LCA model

DATA:

FILE is longitdataset.dat;

VARIABLE:

NAMES ARE id school sex ethnic

schsafe6 socanx6 depress6

schsafe7 socanx7 depress7

schsafe8 socanx8 depress8

vict1s6 vict2s6 vict3s6 vict4s6 vict5s6 vict6s6

vict1s7 vict2s7 vict3s7 vict4s7 vict5s7 vict6s7

vict1s8 vict2s8 vict3s8 vict4s8 vict5s8 vict6s8

physsx9 hsworry9;

IDVARIABLE = id;

MISSING are all(9999);

CLASSES = C(3);

USEVAR = vict1s6 vict2s6 vict3s6 vict4s6 vict5s6 vict6s6;

CATEGORICAL = vict1s6 vict2s6 vict3s6 vict4s6 vict5s6 vict6s6;

CLUSTER = school;

ANALYSIS:

TYPE = mixture missing complex;

STARTS = 50 5;

PROCESS = 2;

OUTPUT: TECH1 TECH8 TECH10 TECH14;

PLOT:

TYPE is plot3 ;

SERIES = vict1s6(1) vict2s6 (2) vict3s6 (3) vict4s6(4) vict5s6(5) vict6s6(6);

SAVEDATA:

SAVE = cprobabilities ;

FILE is grade6_3c_cprob.dat;

Appendix D: Mplus Syntax for LCFA Model with 1-Factor, 2-Classes

TITLE: LTA model with invariant transition probabilities
LCA full measurement invariance.

DATA:

FILE is longitdataset.dat;

VARIABLE:

NAMES ARE id school sex ethnic

schsafe6 socanx6 depress6

schsafe7 socanx7 depress7

schsafe8 socanx8 depress8

vict1s6 vict2s6 vict3s6 vict4s6 vict5s6 vict6s6

vict1s7 vict2s7 vict3s7 vict4s7 vict5s7 vict6s7

vict1s8 vict2s8 vict3s8 vict4s8 vict5s8 vict6s8

physx9 hsworry9;

IDVARIABLE = id;

MISSING are all(9999);

CATEGORICAL = vict1s6 vict2s6 vict3s6 vict4s6 vict5s6 vict6s6

vict1s7 vict2s7 vict3s7 vict4s7 vict5s7 vict6s7

vict1s8 vict2s8 vict3s8 vict4s8 vict5s8 vict6s8 ;

CLASSES = C(2) ;

CLUSTER = school;

USEVAR = vict1s6 vict2s6 vict3s6 vict4s6 vict5s6 vict6s6;

ANALYSIS:

TYPE = mixture missing complex;

ALGORITHM = integration;

STARTS = 150 50;

MODEL:

%Overall%

f by vict1s6* vict2s6 -vict6s6*1.5;

[vict1s6\$1- vict6s6\$1*1.5];

f@0;

%C#1%

[f@1];

%C#2%

[f@0];

OUTPUT:

TECH1 TECH8 TECH10 TECH14;

PLOT:

TYPE is plot3 ;

SERIES = vict1s6(1) vict2s6 (2) vict3s6 (3) vict4s6(4) vict5s6(5) vict6s6(6);

SAVEDATA:

FILE = g6_lcfa_1f2c.dat;

SAVE = cprob;

Appendix E: Mplus Syntax for FMA Model 1-Factor, 2-Classes

TITLE: FMA with full measurement invariance

DATA:

FILE is longitdataset.dat;

VARIABLE:

NAMES ARE id school sex ethnic

Names are id school sex ethnic

schsafe6 socanx6 depress6

schsafe7 socanx7 depress7

schsafe8 socanx8 depress8

vict1s6 vict2s6 vict3s6 vict4s6 vict5s6 vict6s6

vict1s7 vict2s7 vict3s7 vict4s7 vict5s7 vict6s7

vict1s8 vict2s8 vict3s8 vict4s8 vict5s8 vict6s8

physsx9 hsworry9;

IDVARIABLE = id;

MISSING are all(9999);

CATEGORICAL = vict1s6 vict2s6 vict3s6 vict4s6 vict5s6 vict6s6

vict1s7 vict2s7 vict3s7 vict4s7 vict5s7 vict6s7

vict1s8 vict2s8 vict3s8 vict4s8 vict5s8 vict6s8 ;

CLASSES = C(2) ;

CLUSTER = school;

USEVAR = vict1s6 vict2s6 vict3s6 vict4s6 vict5s6 vict6s6;

ANALYSIS:

TYPE = mixture missing complex;

ALGORITHM = integration;

STARTS = 150 50;

MODEL:

%OVERALL%

f by vict1s6@1 vict2s6 – vict6s6 *1.5;

f*2; [f@0];

%C#1%

[vict1s6\$1 – vict6s6\$1*];

%C#2%

[vict1s6\$1 – vict6s6\$1*];

OUTPUT:

TECH1 TECH8 TECH10 TECH14;

PLOT: type is plot3 ;

SERIES = vict1s6(1) vict2s6 (2) vict3s6 (3) vict4s6(4) vict5s6(5) vict6s6(6);

SAVEDATA:

file = g6_fma_1f2c.dat;

save = cprob;

Appendix F: Mplus Syntax for Invariant Transition Probabilities

TITLE: LTA model with invariant transition probabilities
LCA full measurement invariance.

DATA:
FILE is longitdataset.dat;

VARIABLE:
NAMES ARE id school sex ethnic
schsafe6 socanx6 depress6
schsafe7 socanx7 depress7
schsafe8 socanx8 depress8
vict1s6 vict2s6 vict3s6 vict4s6 vict5s6 vict6s6
vict1s7 vict2s7 vict3s7 vict4s7 vict5s7 vict6s7
vict1s8 vict2s8 vict3s8 vict4s8 vict5s8 vict6s8
physsx9 hsworry9;

IDVARIABLE = id;
MISSING are all(9999);
CATEGORICAL = vict1s6 vict2s6 vict3s6 vict4s6 vict5s6 vict6s6
vict1s7 vict2s7 vict3s7 vict4s7 vict5s7 vict6s7
vict1s8 vict2s8 vict3s8 vict4s8 vict5s8 vict6s8 ;
CLASSES = C1(3) C2(3) C3(3);
CLUSTER = school;

USEVAR = vict1s6 vict2s6 vict3s6 vict4s6 vict5s6 vict6s6
vict1s7 vict2s7 vict3s7 vict4s7 vict5s7 vict6s7
vict1s8 vict2s8 vict3s8 vict4s8 vict5s8 vict6s8 ;

ANALYSIS:
TYPE = mixture missing complex;
STARTS = 50 10;
PROCESS = 2;

MODEL:
%Overall% *! Constraining transition probabilities to be the same*
[C2#1] (101);
[C2#2] (102);
[C3#1] (101);
[C3#2] (102);

C2#1 on C1#1 (111);
C2#1 on C1#2 (112);
C2#2 on C1#1 (113);

C2#2 on C1#2 (114);

C3#1 on C2#1 (111);

C3#1 on C2#2 (112);

C3#2 on C2#1 (113);

C3#2 on C2#2 (114);

MODEL C1: *! Measurement model for grade 6*

%C1#1%

[vict1s6\$1- vict6s6\$1] (1-6); *! The (1-6) labeling the item thresholds, which will be held
!equal across time*

%C1#2%

[vict1s6\$1- vict6s6\$1] (7-12);

%C1#3%

[vict1s6\$1- vict6s6\$1] (13-18);

MODEL C2: *! Measurement model for grade 7*

%C2#1%

[vict1s7\$1- vict6s7\$1] (1-6);

%C2#2%

[vict1s7\$1- vict6s7\$1] (7-12);

%C2#3%

[vict1s7\$1- vict6s7\$1] (13-18);

MODEL C3: *! Measurement model for grade 8*

%C3#1%

[vict1s8\$1- vict6s8\$1] (1-6);

%C3#2%

[vict1s8\$1- vict6s8\$1] (7-12);

%C3#3%

[vict1s8\$1- vict6s8\$1] (13-18);

OUTPUT:

TECH1 TECH8 TECH10;

Appendix G: Mplus Syntax for the Second-Order LTA Model

TITLE: LTA Model with second-order effect, no covariates,
LCA full measurement invariance.

DATA:

FILE is longitdataset.dat;

VARIABLE:

NAMES ARE id school sex ethnic

schsafe6 socanx6 depress6

schsafe7 socanx7 depress7 schsafe8 socanx8 depress8

vict1s6 vict2s6 vict3s6 vict4s6 vict5s6 vict6s6

vict1s7 vict2s7 vict3s7 vict4s7 vict5s7 vict6s7

vict1s8 vict2s8 vict3s8 vict4s8 vict5s8 vict6s8

physym9 hsworry9;

IDVARIABLE = id;

MISSING are all(9999);

CATEGORICAL = vict1s6 vict2s6 vict3s6 vict4s6 vict5s6 vict6s6

vict1s7 vict2s7 vict3s7 vict4s7 vict5s7 vict6s7

vict1s8 vict2s8 vict3s8 vict4s8 vict5s8 vict6s8 ;

CLASSES = C1(3) C2(3) C3(3);

CLUSTER = school;

USEVAR = vict1s6 vict2s6 vict3s6 vict4s6 vict5s6 vict6s6

vict1s7 vict2s7 vict3s7 vict4s7 vict5s7 vict6s7

vict1s8 vict2s8 vict3s8 vict4s8 vict5s8 vict6s8;

ANALYSIS:

TYPE = mixture missing complex;

STARTS = 50 10;

PROCESS = 2;

MODEL:

%Overall%

C2#1 on C1#1; !*Time 2 on Time 1 (first-order effect)*

C2#1 on C1#2;

C2#2 on C1#1;

C2#2 on C1#2;

C3#1 on C2#1; !*Time 3 on Time 2 (first-order effect)*

C3#1 on C2#2;

C3#2 on C2#1;

C3#2 on C2#2;

C3#1 on C1#1; *! Time 3 on Time 1 (second-order effect)*
C3#1 on C1#2;
C3#2 on C1#1;
C3#2 on C1#2;

MODEL C1:

%C1#1%
[vict1s6\$1- vict6s6\$1] (1-6);
%C1#2%
[vict1s6\$1- vict6s6\$1] (7-12);
%C1#3%
[vict1s6\$1- vict6s6\$1] (13-18);

MODEL C2:

%C2#1%
[vict1s7\$1- vict6s7\$1] (1-6);
%C2#2%
[vict1s7\$1- vict6s7\$1] (7-12);
%C2#3%
[vict1s7\$1- vict6s7\$1] (13-18);

MODEL C3:

%C3#1%
[vict1s8\$1- vict6s8\$1] (1-6);
%C3#2%
[vict1s8\$1- vict6s8\$1] (7-12);
%C3#3%
[vict1s8\$1- vict6s8\$1] (13-18);

PLOT:

TYPE = plot3 ;
SERIES = vict1s6 (1) vict2s6 (2) vict3s6 (3) vict4s6(4) vict5s6(5) vict6s6(6)
vict1s7 (7) vict2s7 (8) vict3s7 (9) vict4s7(10) vict5s7(11) vict6s7(12)
vict1s8 (13) vict2s8 (14) vict3s8(15) vict4s8(16) vict5s8(17) vict6s8(18);

OUTPUT:

TECH1 TECH10;

Appendix H: Mplus Syntax for First-Order LTA Model with Covariates, a Mover-Stayer Latent Variable, and a Distal Outcome (physical symptoms)

TITLE: LTA model with M-S variable, covariate, and distal outcome.

DATA:

FILE is longitdataset.dat;

VARIABLE:

NAMES ARE id school sex ethnic

schsafe6 socanx6 depress6

schsafe7 socanx7 depress7

schsafe8 socanx8 depress8

vict1s6 vict2s6 vict3s6 vict4s6 vict5s6 vict6s6

vict1s7 vict2s7 vict3s7 vict4s7 vict5s7 vict6s7

vict1s8 vict2s8 vict3s8 vict4s8 vict5s8 vict6s8

physym9 hsworry9;

IDVARIABLE = id;

MISSING are all(9999);

CATEGORICAL = vict1s6 vict2s6 vict3s6 vict4s6 vict5s6 vict6s6

vict1s7 vict2s7 vict3s7 vict4s7 vict5s7 vict6s7

vict1s8 vict2s8 vict3s8 vict4s8 vict5s8 vict6s8;

CLASSES = C1(3) C2(3) C3(3);

CLUSTER = school;

USEVAR = schsafe6 depress6 socanx6

schsafe7 depress7 socanx7

schsafe8 depress8 socanx8

physyx9

vict1s6 vict2s6 vict3s6 vict4s6 vict5s6 vict6s6

vict1s7 vict2s7 vict3s7 vict4s7 vict5s7 vict6s7

vict1s8 vict2s8 vict3s8 vict4s8 vict5s8 vict6s8

female afam latino asian multi;

CLUSTER = school;

CLASSES = C (2) C1(3) C2(3) C3(3);

DEFINE:

IF (sex eq 0) THEN female = 0;

IF (sex eq 1) THEN female = 1;

IF (ethnic eq 2) THEN afam = 1;

```

IF (ethnic ne 2) THEN afam = 0;
IF (ethnic eq 3) THEN latino = 1;
IF (ethnic ne 3) THEN latino = 0;
IF (ethnic eq 4) THEN asian = 1;
IF (ethnic ne 4) THEN asian = 0;
IF (ethnic eq 5) THEN multi = 1;
IF (ethnic eq 6) THEN multi = 1;

```

ANALYSIS:

```

TYPE = mixture missing complex;
STARTS = 225 50;
PROCESS = 2;

```

MODEL:

```

%overall%
!c is the mover-stayer latent variable
!c#1 is the mover class
!c#2 is the stayer class

!c1, c2, c3 are the time-specific victimization classes

! Relating c1, c2, c3 to c: (Movers)
[C1#1];
[C1#2];
[C2#1];
[C2#2];
C1#1 on C#1;
C1#2 on C#1;
C2#1 on C#1;
C2#2 on C#1;
C3#1 on C#1;
C3#2 on C#1;

! Relating c2 and c3 to c: (Stayers)
[C2#1@-15]; !"a1" - probability of transitioning from VI
! at grade 6 to SV at grade 7 is fixed
! at zero for the stayer class
[C2#2@-15]; ! These statements are fixing cells of transition matrix for stayers
[C3#1@-15];
[C3#2@-15];

C1#1 C1#2 on female schsafe6 depress6 socanx6;
C2#1 C2#2 on female schsafe7 depress7 socanx7;
C3#1 C3#2 on female schsafe8 depress8 socanx8;
! the above statements regresses the time specific victim classes on the four covariates

```

C#1 on female afam latino asian multi;
! the above statement regresses the mover/ stayer variable on gender and ethnicity

MODEL C:

%C#1% *!mover class*
 C2#1 on C1#1; *!"b11" – mover class transition prob's are freely estimated*
 C2#1 on C1#2; *!b12*
 C2#2 on C1#1; *!b21*
 C2#2 on C1#2; *!b22*

 C3#1 on C2#1; *!"b11" - !mover class transition prob's are freely estimated*
 C3#1 on C2#2; *!b12*
 C3#2 on C2#1; *!b21*
 C3#2 on C2#2; *!b22*

%C#2% *!stayer class*
 C2#1 on C1#1@30; *!"b11" - stayer class has prob 1 of staying*
 C2#1 on C1#2@-45; *!b12*
 C2#2 on C1#1@-45; *!b21*
 C2#2 on C1#2@30; *!b22*

 C3#1 on C2#1@30; *!"b11" - stayer class has prob 1 of staying*
 C3#1 on C2#2@-45; *!b12*
 C3#2 on C2#1@-45; *!b21*
 C3#2 on C2#2@30; *!b22*

MODEL C.C1:

%C#1.C1#1% *!c#1.c1#1 are the movers who are VI in Grade 6*
 [vict1s6\$1- vict6s6\$1] (1-6);

 %C#1.C1#2% *!c#1.c1#2 are the movers who are SV in Grade 6*
 [vict1s6\$1- vict6s6\$1] (7-12);

 %C#1.C1#3% *!c#1.c1#3 are the movers who are NV in Grade 6*
 [vict1s6\$1- vict6s6\$1] (13-18);

 %C#2.C1#1% *!c#2.c1#1 are the stayers who are VI in Grade 6*
 [vict1s6\$1- vict6s6\$1] (1-6);
 [physx9] (p3); *! Estimating a mean for the VI stayers*
 %C#2.C1#2% *!c#2.c1#2 are the stayers who are SV in Grade 6*
 [vict1s6\$1- vict6s6\$1] (7-12); *! Estimating a mean for the SV stayers*
 [physx9] (p6);
 %C#2.C1#3% *!c#2.c1#3 are the stayers who are in NV in Grade 6*
 [vict1s6\$1- vict6s6\$1] (13-18); *! Estimating a mean for the NV stayers*
 [physx9] (p9);

MODEL C.C2:

%C#1.C2#1% *!c#1.c2#1 are the movers who are in VI in Grade 7*
[vict1s7\$1- vict6s7\$1] (1-6);

%C#1.C2#2% *!c#1.c2#2 are the movers who are in SV in Grade 7*
[vict1s7\$1- vict6s7\$1] (7-12);

%C#1.C2#3% *!c#1.c2#3 are movers who are in NV in Grade 7*
[vict1s7\$1- vict6s7\$1] (13-18);

%C#2.C2#1%
[vict1s7\$1- vict6s7\$1] (1-6);

%C#2.C2#2%
[vict1s7\$1- vict6s7\$1] (7-12);

%C#2.C2#3%
[vict1s7\$1- vict6s7\$1] (13-18);

MODEL C.C3:

%C#1.C3#1%
[vict1s8\$1- vict6s8\$1] (1-6);

%C#1.C3#2%
[vict1s8\$1- vict6s8\$1] (7-12);

%C#1.C3#3%
[vict1s8\$1- vict6s8\$1] (13-18);

%C#2.C3#1%
[vict1s8\$1- vict6s8\$1] (1-6);

%C#2.C3#2%
[vict1s8\$1- vict6s8\$1] (7-12);

%C#2.C3#3%
[vict1s8\$1- vict6s8\$1] (13-18);

MODEL TEST:

p3 = p6;

SAVEDATA:

FILE is ltamodel.dat;
SAVE = cprobabilities;

Appendix I: Mplus Syntax for Second-Order LTA Model with Covariates and a Distal Outcome that Varies for Each Class of C3

TITLE: LTA model 2nd-order effect, covariates, and distal outcome.

DATA:

FILE is longitdataset.dat;

VARIABLE:

NAMES ARE id school sex ethnic

schsafe6 socanx6 depress6
schsafe7 socanx7 depress7
schsafe8 socanx8 depress8
vict1s6 vict2s6 vict3s6 vict4s6 vict5s6 vict6s6
vict1s7 vict2s7 vict3s7 vict4s7 vict5s7 vict6s7
vict1s8 vict2s8 vict3s8 vict4s8 vict5s8 vict6s8
physym9 hsworry9;

IDVARIABLE = id;

MISSING are all(9999);

CATEGORICAL = vict1s6 vict2s6 vict3s6 vict4s6 vict5s6 vict6s6
vict1s7 vict2s7 vict3s7 vict4s7 vict5s7 vict6s7
vict1s8 vict2s8 vict3s8 vict4s8 vict5s8 vict6s8;

CLASSES = C1(3) C2(3) C3(3);

CLUSTER = school;

ANALYSIS: Type = mixture missing complex;

STARTS = 250 50;

PROCESS = 2;

DEFINE:

If (sex01 eq 0) THEN female = 0;

If (sex01 eq 1) THEN female = 1;

MODEL:

%Overall%

C2#1 on C1#1; !*Time 2 on Time 1 (first-order effect)*

C2#1 on C1#2;

C2#2 on C1#1;

C2#2 on C1#2;

C3#1 on C2#1; !*Time 3 on Time 2 (first-order effect)*

C3#1 on C2#2;

C3#2 on C2#1;

C3#2 on C2#2;

```
C3#1 on C1#1;      ! Time 3 on Time 1 (second-order effect)
C3#1 on C1#2;
C3#2 on C1#1;
C3#2 on C1#2;
```

MODEL C1:

```
C1#1 C1#2 on schsafe6 socanx6 depress6 female;
C2#1 C2#2 on schsafe7 socanx7 depress7 female;
C3#1 C3#2 on schsafe8 socanx8 depress8 female;
```

MODEL C1:

```
%C1#1%
[vict1s6$1- vict6s6$1] (1-6);
%C1#2%
[vict1s6$1- vict6s6$1] (7-12);
%C1#3%
[vict1s6$1- vict6s6$1] (13-18);
```

MODEL C2:

```
%C2#1%
[vict1s7$1- vict6s7$1] (1-6);
%C2#2%
[vict1s7$1- vict6s7$1] (7-12);
%C2#3%
[vict1s7$1- vict6s7$1] (13-18);
```

MODEL C3:

```
%C3#1%
[vict1s8$1- vict6s8$1] (1-6);
[physym9];      ! Estimating the distal outcome mean for each class of c3.
%C3#2%
[vict1s8$1- vict6s8$1] (7-12);
[physym9];      ! Estimating the distal outcome mean for each class of c3.
%C3#3%
[vict1s8$1- vict6s8$1] (13-18);
[physym9];      ! Estimating the distal outcome mean for each class of c3.
```

SAVEDATA:

```
FILE is ltasecondorderphysical.dat;
SAVE = cprob;
```

OUTPUT:

```
TECH1 TECH10;
```

References

- Agresti, A. (2002). *Categorical Data Analysis*, (2nd ed.), New York: Wiley.
- Asparouhov, T. & Muthén, B. (in press). Multilevel mixture models. In G. R. Hancock & K. M. Samuelsen, K. M. (Eds.). *Advances in Latent Variable Mixture Models*. Charlotte, NC: Information Age Publishing, Inc.
- Archer, J. & Coyne, S. M. (2005). An integrated review of indirect, relational, and social aggression. *Personality and Social Psychology Review*, *9*, 212-230.
- Baum, L. E., Petrie, T., Soules, G., & Weiss, N. (1970). A maximization technique occurring in the statistical analysis of probabilistic function of Markov chains. *Annals of Mathematical Statistics*, *41*, 164-171.
- Bellmore, A. D., & Cillessen, A. H. N. (2006). Reciprocal influences of victimization, perceived social preference, and self-concept in adolescence. *Self and Identity*, *5*, 209-229.
- Böckenholt, U. (2005). A latent Markov model for the analysis of longitudinal data collected in continuous time: States, durations, and transitions. *Psychological Methods*, *10*, 65-83.
- Boivin, M., Hymel, S., & Hodges, E. V. E. (2001). Toward a process view of peer rejection and harassment. In J. Juvonen, & S. Graham (Eds.), *Peer harassment in school: The plight of the vulnerable and victimized* (pp. 265-289). New York: Guilford Press.
- Bollen, K. (1989). *Structural equations with latent variables*. New York: John Wiley.
- Collins, L. M. & Cliff, N. (1990). Using the Longitudinal Guttman Simplex as a basis for measuring growth. *Psychological Bulletin*, *108*, 128-134.

- Collins, L. M. & Sayer, A. G., Eds. (2001). *New methods for the analysis of change*. Washington, D.C.: American Psychological Association.
- Curran, P. J. & Bollen, K. A. (2001). *The best of both worlds: Combining autoregressive and latent curve models*. In L. Collins & A. Sayer (Eds.), *New methods for the analysis of change*, (pp. 107-35). Washington, DC: American Psychological Association.
- Dempster, A. P., Laird, N. M., & Rubin, D. B. (1977). Maximum likelihood from incomplete data via the EM algorithm (with discussion). *Journal of the Royal Statistical Society*, *39*, 1–38.
- Duncan, T. E., Duncan, S. C., Strycker, L. A., Li, F., & Alpert, A. (1999). *An introduction to latent variable growth curve modeling: Concepts, issues, and applications*. Mahwah, NJ: Lawrence Erlbaum Associates.
- Enders, C. K. & Bandalos, D. L. (2001). The relative performance of full information maximum likelihood estimation for missing data in structural equation models. *Structural Equation Modeling: A Multidisciplinary Journal*, *8*, 430-457.
- Fitzmaurice, G. M., Laird, N. M., & Ware, J. H. (2004). *Applied longitudinal analysis*. New York: Wiley.
- Gottfredson, G. (1984). *Effective school battery*. Psychological Assessment Resources.
- Graham, J. W., Collins, L. M., Wugalter, S. E., Chung, N. K., & Hansen, W. B. (1991). Modeling transitions in latent stage-sequential processes: A substance use prevention example. *Journal of Consulting and Clinical Psychology*, *59*, 48-57.
- Graham, S., Bellmore, A. D., & Mize, J. (2006). Aggression, victimization, and their co-occurrence in middle school. *Journal of Abnormal Child Psychology*, *34*, 363-378.

- Graham, S., & Juvonen, J. (1998). Self-blame and peer victimization in middle school: an attributional analysis. *Developmental Psychology, 34*, 587-599.
- Haberman, S. T. (1973). The Analysis of Residuals in Cross-Classified Tables, *Biometrics, 29*, 205-220.
- Harter, S. (1987). *Manual for the self-perception profile for children*. Denver, CO: University of Denver.
- Hawker, D. S. J. & Boulton, M. J. (2000). Twenty years research on peer victimization and psychosocial maladjustment: a meta-analytic review of cross-sectional studies. *The Journal of Child Psychology and Psychiatry and Allied Disciplines, 41*, 441-455.
- Hedeker, D. & Gibbons, R. D. (1994). A random-effects ordinal regression model for multilevel analysis. *Biometrics, 50*, 933-944.
- Humphreys, K., & Janson, H. (2000). Latent transition analysis with covariates, nonresponse, summary statistics and diagnostics. *Multivariate Behavioral Research, 35*, 89-118.
- Juvonen, J., & Graham, S. (2001). *Peer harassment in school: The plight of the vulnerable and victimized*. New York: Guilford Press.
- Juvonen, J., Graham, S., & Schuster, M. (2003). Bullying among young adolescents: The strong, the weak, and the troubled. *Pediatrics, 112*, 1231-1237.
- Juvonen, J., Nishina, A. & Graham, S. (2000). Peer harassment, psychological adjustment, and school functioning in early adolescence. *Journal of Educational Psychology, 92*(2), 349-359.
- Kaufman, P., Chen, X., Choy, S. P., Ruddy, S. A., Miller, A. K., Chandler, K. A., et al. (1999). *Indicators of School Crime and Safety*. (NCES 1999-057/NCJ-178906). Washington, DC: Departments of Education and Justice.

- Kovacs, M. (1992). *Children's depression inventory*. North Tonawanda, NY: Multi-Health Systems.
- La Greca, A. M. & Lopez, N. (1998). Social Anxiety among adolescents: Linkages with peer relations and friendship. *Journal of Abnormal Child Psychology*, 26, 83-94.
- Ladd, G. W. & Kochenderfer-Ladd, B. (2002). Identifying victims of peer aggression from early to middle childhood: Analysis of cross-informant data for concordance, estimation of relational adjustment, prevalence of victimization, and characteristics of identified victims. *Psychological Assessment*, 14, 74-96.
- Langeheine, R. & Van de Pol, F. (1994). Discrete-time mixed Markov latent class models. In A. Dale & R. B. Davies (Eds.), *Analyzing Social and Political Change: a Casebook of Methods* (pp. 171-197). London: Sage Publications.
- Lazarsfeld, P. & Henry, N. (1968). *Latent Structure Analysis*. New York: Houghton Mifflin.
- Little, T. D., Jones, S. M., Henrich, C. C., & Hawley, P. H. (2003). Disentangling the “whys” from the “whats” of aggressive behavior. *International Journal of Behavioral Development*, 27, 122-133.
- Lubke, G. H. & Muthén, B. (2005). Investigating population heterogeneity with factor mixture models. *Psychological Methods*, 10, 21-39.
- Magnusson, D. & Cairns, R. B. (1996). Developmental science: Toward a unified framework. In R. B. Cairns, & G. H. Elder Jr. (Eds.), *Developmental Science. Cambridge Studies in Social and Emotional Development* (pp. 7-30). New York: Cambridge University Press.
- Masyn, K. E. (In press). Modeling measurement error in event occurrence for single, non-recurring events in discrete-time survival analysis. In G. R. Hancock & K. M.

- Samuelsen, K. M. (Eds.). *Advances in Latent Variable Mixture Models*. Charlotte, NC: Information Age Publishing, Inc.
- McLachlan, G. & Peel, D. (2000). *Finite Mixture Models*. New York: Wiley.
- Molenberghs G. & Verbeke G. (2005). *Models for Discrete Longitudinal Data*. New York: Springer-Verlag.
- Mooijaart, A. (1998). Log-linear and Markov modeling of categorical longitudinal data. In C. J. H. Bijleveld & T. van der Kamp (Eds.). *Longitudinal data analysis: Designs, models, and methods*. (page numbers) Newbury Park: Sage.
- Muthén, B. (2001). Latent variable mixture modeling. In G. Marcoulides & R. Schumacker (Eds.), *New developments and techniques in structural equation modeling* (pp. 1-33). Mahwah, NJ: Lawrence Erlbaum Associates.
- Muthén, B. (2002). Beyond SEM: General latent variable modeling. *Behaviormetrika*, 29, 81-117.
- Muthén, B. (2006). Should substance use disorders be considered as categorical or dimensional? *Addiction*, 101 (Suppl. 1), 6-16.
- Muthén, B. & Asparouhov, T. (2006). Item response mixture modeling: Application to tobacco dependence criteria. *Addictive Behaviors*, 31, 1050-1066.
- Muthén, B., Brown, C. H., Masyn, K., Jo, B., Khoo, S. T., Yang, C. C., et al. (2002). General growth mixture modeling for randomized preventive interventions. *Biostatistics*, 3, 459-475.
- Muthén, L. & Muthén, B. (1998-2007). *Mplus User's Guide*. Fourth Edition. Los Angeles, CA: Muthén & Muthén.

- Muthén, B., & Shedden, K. (1999). Finite mixture modeling with mixture outcomes using the EM algorithm. *Biometrics*, *55*, 463-469.
- Nansel, T. R., Overpeck, M., Pilla, R. S., Ruan, W. J., Simons-Morton, B., & Scheidt, P. (2001). Bullying behaviors among US youth: Prevalence and association with psychosocial adjustment. *Journal of the American Medical Association*, *285*, 2094-2100.
- Neary, A., & Joseph, S. (1994). Peer victimization and its relationship to self-concept and depression among schoolgirls. *Personality and Individual Differences*, *16*, 183-186.
- Nishina, A., Bellmore, M., Witkow, M. R., & Nylund, K. (2006, March). *Who Am I? The Development of Ethnic Identification in a Multi-ethnic Society*. Poster presented at the biannual meeting of the Society for Research on Adolescents, San Francisco, CA.
- Nukulkij, P., Whitcomb, M. Bellmore, A., & Cillessen, A. (1999, April). *Academic and social expectations and actual school performance across the transition to middle school*. Poster session present at the biennial meeting of the Society for Research in Child Development, Albuquerque, NM.
- Nylund, K. L., Asparouhov, T., Muthén, B. O. (in press). Deciding on the number of classes in latent class analysis and growth mixture modeling: A Monte Carlo simulation study. *Structural Equation Modeling: An Interdisciplinary Journal*.
- Olweus, D. (1993). *Bullying at school: what we know and what we can do*. Oxford: Blackwell.
- Perry, D. G., Kusel, S. J., & Perry, L. C. (1988). Victims of peer aggression. *Developmental Psychology*, *24*, 807-814.
- Raudenbush, S. W. & Bryk, A. S. (2002). *Hierarchical linear models: Applications and data analysis methods*. (2nd ed.). Newbury Park, CA: Sage Publications.
- Reboussin, B. A., Reboussin, D. M., Liang, K. Y., & Anthony, J. C. (1998). Latent transition

- modeling of progression of health-risk behavior. *Multivariate Behavioral Research*, 33, 457-478.
- Resnick, M. D., Bearman, P. S., Blum, R. W., Bauman, K. E., Harris, K. M., Jones, J., et al. (1997). Protecting adolescents from harm: Findings from the national longitudinal study on adolescent health. *Journal of the American Medical Association*, 278, 823-832.
- Roeser, R. W. & Eccles, J. S. (1998). Adolescents' perceptions of middle school: Relation to longitudinal changes in academic and psychological adjustment. *Journal of Research on Adolescence*, 88, 123-158.
- Salmivalli, C. (2002). Is there an age decline in victimization by peers at school? *Educational Research*, 44, 269-277.
- Schwartz, D. (2000). Subtypes of victims and aggressors in children's peer groups. *Journal of Abnormal Child Psychology*, 28, 181-192.
- Schwartz, G. (1978). Estimating the dimension of a model. *The Annals of Statistics*, 6, 461-464.
- Sclove, L. (1987). Application of model-selection criteria to some problems in multivariate analysis. *Psychometrika*, 52, 333-343.
- Seidman, E., Allen, L. Aber, J. L., Mitchell, C., & Feinman, J. (1994). The impact of school transitions in early adolescence on the self-system and perceived social context of poor urban youth. *Child Development*, 65, 507-522.
- Singer, J. & Willett, J. (2003). *Applied longitudinal data analysis*. New York: Oxford University Press.
- Smith, P. K., Cowie, H., Olafsson, R. F., & Liefhoghe, A. P. D. (2002). Definitions of bullying: A comparison of terms used, and age and gender differences, in a fourteen-country international comparison. *Child Development*, 73, 1119-1133.

- Smith, P. K., Madsen, K. C., & Moody, J. C. (1999). What causes the age decline in reports of being bullied at school?: Towards a developmental analysis of risks of being bullied. *Educational Research, 41*, 267-285.
- Smith, P. K., Cowie, H., Olafsson, R. F., & Liefhoghe, A. P. D. (2002). Definitions of bullying: A comparison of terms used, and age and gender differences, in a fourteen-country international comparison. *Child Development, 73*, 1119-1133.
- Smith, P. K., Madsen, K. C., & Moody, J. C. (1999). What causes the age decline in reports of being bullied at school?: Towards a developmental analysis of risks of being bullied. *Educational Research, 41*, 267-285.
- Solberg, M. & Olweus, D. (2003). Prevalence estimation of school bullying with the Olweus Bully/Victim Questionnaire. *Aggressive Behavior, 29*, 239-268.
- Udry, J. R., & Bearman, P. S. (1998). New methods for new research on adolescent sexual behavior. In R. Jessor (Ed). *New perspectives on adolescent risk behavior* (pp. 241-269). New York: Cambridge University Press.
- Van de Pol, F., & Langeheine, R. (1990). Mixed Markov latent class models. In C. C. Clogg (Ed.), *Sociological Methodology* (pp. 213-247). Oxford: Blackwell.
- Vermunt, J.K. (2004). Latent profile model. In M. S. Lewis-Beck, A. Bryman, & T.F. Liao (Eds.), *The sage encyclopedia of social sciences research methods* (pp. 554-555). Thousand Oakes, CA: Sage Publications.
- Vermunt, J.K., Langeheine, R., & Böckenholt, U. (1999). Latent Markov models with time-constant and time varying-covariates. *Journal of Educational and Behavioral Statistics, 24*, 178-205.
- Wiggins, L. M. (1973). *Panel Analysis*. Amsterdam: Elsevier.